

TRANSLATION OF THE ORIGINAL VERSION

CE



Operating Manual

Under-Table Cross-Cut Saws

UTK 350 / UTK 450 / UTK 500 / UTK 600



Machine Types: Under-table cross-cut saws of the UTK series

Reinhold Beck Maschinenbau GmbH

Im Grund 23 | DE -72505 Krauchenwies

Tel.: +49 (0) 7576 / 962 978 - 0 | Fax: +49 (0) 7576 / 962 978 - 90

E-Mail: info@beck-maschinenbau.de | Web: <https://www.beck-maschinenbau.de>

Space for notes:

Reinhold Beck Maschinenbau GmbH
 Im Grund 23, DE 72505 Krauchenwies
 Phone: +49 (0) 7576 962978-0
 Fax: +49 (0) 7576 962978-90

<h2>Handover Certificate</h2>		
Machine type:		
Machine no.:		
Construction year:		
Customer address (location of the machine):		
Name:		
Street:		
Postcode/City:		
Phone:		
E-mail:		
<p>Warranty:</p> <p>On the basis of our Terms and Conditions of Sale, Delivery and Payment of the respective current status, we assume a warranty of 12 months, calculated from the day of delivery, for material defects and defects of title in connection with the delivery for the above-mentioned machine.</p>		
<p>Warranty claims:</p> <p>Warranty claims against R. Beck Maschinenbau GmbH are only valid if this handover declaration has been completed, signed and handed over to R. Beck Maschinenbau GmbH and the machine has been properly put into operation.</p> <p>Important: Please read and follow the instructions in chapter ⇨ 1 "Liability and Warranty".</p>		
<p>Confirmation of the buyer:</p> <ul style="list-style-type: none"> ✓ The machine described above was purchased by the buyer. ✓ The machine was handed over with the corresponding operating manual, edition: _____ ✓ The contents of the operating manual are acknowledged by the buyer. ✓ Persons who are commissioned to work on this machine will be provided with the operating manual and will receive safety training. 		
_____ Name and position	_____ Date	_____ Signature of the customer
<p>Address of the dealer (company stamp):</p>	<p>The machine, including the operating manual, was handed over to the buyer and installed according to the specifications in the operating manual.</p>	
	_____ Date	_____ Signature - Customer Service

Space for notes:

Reinhold Beck Maschinenbau GmbH
 Im Grund 23, DE 72505 Krauchenwies
 Phone: +49 (0) 7576 962978-0
 Fax: +49 (0) 7576 962978-90

<h1>Handover Certificate</h1>		
Machine type:		
Machine no.:		
Construction year:		
Customer address (location of the machine):		
Name:		
Street:		
Postcode/City:		
Phone:		
E-mail:		
<p>Warranty:</p> <p>On the basis of our Terms and Conditions of Sale, Delivery and Payment of the respective current status, we assume a warranty of 12 months, calculated from the day of delivery, for material defects and defects of title in connection with the delivery for the above-mentioned machine.</p>		
<p>Warranty claims:</p> <p>Warranty claims against R. Beck Maschinenbau GmbH are only valid if this handover declaration has been completed, signed and handed over to R. Beck Maschinenbau GmbH and the machine has been properly put into operation.</p> <p>Important: Please read and follow the instructions in chapter ⇨ 1 "Liability and Warranty".</p>		
<p>Confirmation of the buyer:</p> <ul style="list-style-type: none"> ✓ The machine described above was purchased by the buyer. ✓ The machine was handed over with the corresponding operating manual, edition: _____ ✓ The contents of the operating manual are acknowledged by the buyer. ✓ Persons who are commissioned to work on this machine will be provided with the operating manual and will receive safety training. 		
_____ Name and position	_____ Date	_____ Signature of the customer
<p>Address of the dealer (company stamp):</p>	<p>The machine, including the operating manual, was handed over to the buyer and installed according to the specifications in the operating manual.</p>	
	_____ Date	_____ Signature - Customer Service

Table of contents

1	Liability and warranty	10
2	Introduction	11
2.1	Legal notice	11
2.2	Illustrations	11
3	Symbols	11
3.1	General Symbols	11
3.2	Symbols in safety instructions	12
4	General	13
4.1	Structure and function	13
4.2	Standard equipment	13
4.3	Available optional accessories	14
4.4	Target group and previous experience	14
4.5	Training of the personnel.....	14
4.6	Requirements for the Operators.....	15
4.7	Accident Prevention.....	15
4.8	General Safety Regulations	15
5	Safety.....	16
5.1	Basic safety instructions.....	16
5.1.1	Area of application and intended use	16
5.1.2	Prohibition of misuse	16
5.1.3	Environmental conditions	16
5.1.4	Modifications and conversions to the machine	16
5.1.5	Permissible workpiece cross-sections	17
5.1.6	Machinable workpiece lengths	18
5.1.7	Usable circular saw blades	18
5.1.8	Working areas at the machine	18
5.1.9	Residual risks.....	19
5.1.10	Observe the environmental protection regulations.....	20
5.1.11	Organisational measures.....	20
5.1.12	Personnel selection and qualification - basic duties	21
5.2	Existing safety equipment.....	21
5.3	Safety instructions for specific phases of operation	22
5.3.1	Before starting work	22
5.3.2	Normal operation.....	23
5.3.3	Special work within the scope of maintenance work as well as troubleshooting in the workflow	24
5.4	Hazardous areas on the under-table cross-cut saw	25
6	Machine data	26
6.1	Technical specifications	26
6.2	Emission levels	27
6.2.1	Noise information	27

6.2.2	Noise emission values	27
6.2.3	Dust emission values	27
7	Dimensions	28
7.1	UTK 350	28
7.2	UTK 450	28
7.3	UTK 500	29
7.4	UTK 600	29
8	Installation and connection	30
8.1	Check delivery conditions	30
8.2	Transport to the installation site	30
8.3	Machine installation	31
8.4	Temporary storage	31
8.5	Lashing in a transport vehicle	32
8.6	Workplace requirements	33
8.7	Electrical connection	34
8.7.1	Supply cable and back-up fuse	34
8.8	Connecting the extraction system	35
8.8.1	Automatic switching of the extraction system	35
8.9	Pneumatic connection	36
9	Components and controls	37
10	Commissioning	38
10.1	Control switches and signal lamps	38
10.2	Frequent switching ON and OFF in succession	39
10.3	Home position	39
10.4	Two-hand safety control	39
10.5	Regulating the lifting speed	39
10.6	Door interlock with safety switch	40
10.7	Installing a circular saw blade	41
11	Working with the under-table cross-cut saw	42
11.1	Pneumatic clamping guard	42
11.1.1	Function of the clamping guard	42
11.2	Protective shield	42
11.3	Lowerable protective shield (pneumatic option)	43
11.4	Full protection cover with viewing window (option)	43
11.5	Workpiece fence	43
11.5.1	Options in addition to the workpiece fence	44
11.6	Safe workpiece support	44
11.7	Condition of the circular saw blade	45
11.8	Sequence of workpiece machining	45
11.8.1	Adjust the lifting speed	45
11.8.2	Feeding and positioning the workpiece	45

11.8.3	Triggering the cutting stroke	46
11.9	Interruptions and end of work	47
11.10	Laser cutting line indicator (option)	47
11.10.1	Particularities when using the laser cutting line indicator	47
12	Troubleshooting	48
12.1	Behaviour in the case of a power failure	48
12.2	General faults	49
12.3	Fault messages of the safety PLC	50
12.3.1	Monitoring the end positions and valves	50
12.3.2	Illuminated push button (L2) for operating pressure	50
13	Maintenance and inspection	51
13.1	Lubrication of the machine	51
13.2	General maintenance intervals	51
13.3	Check wear rail for circular saw blade	52
13.3.1	Fitting and sawing in the replacement wear rail	52
13.4	Tensioning the drive belts	53
13.4.1	Adjusting the correct V-belt tension	53
13.4.2	Retensioning the V-belt on model UTK 350	53
13.4.3	Retensioning the V-belt on model UTK 450	53
13.4.4	Retensioning the V-belt on model UTK 500	54
13.4.5	Retensioning the V-belt on model UTK 600	54
13.5	Replacing the drive belts	55
13.6	Readjust motor brake	56
13.6.1	Replacing the motor brake	56
14	Options and accessories	57
14.1	UTK 350	57
14.1.1	Circular saw blades	57
14.1.1	Options and accessories	57
14.2	UTK 450	57
14.2.1	Circular saw blades	57
14.2.1	Options and accessories	57
14.3	UTK 500	58
14.3.1	Circular saw blades	58
14.3.1	Options and accessories	58
14.4	UTK 600	58
14.4.1	Circular saw blades	58
14.4.2	Options and accessories	58
15	Disassembly and scrapping	59
	EU - Declaration of Conformity	60

List of figures

Figure 1: machining process on the UTK.....	13
Figure 2: permissible workpiece cross-sections UTK 350	17
Figure 3: permissible workpiece cross-sections UTK 450	17
Figure 4: permissible workpiece cross-sections UTK 500	17
Figure 5: permissible workpiece cross-sections UTK 600	17
Figure 6: danger zones on the under-table cross-cut saw	25
Figure 7: name plate.....	26
Figure 8: UTK 350 dimensions	28
Figure 9: UTK 450 dimensions	28
Figure 10: UTK 500 dimensions	29
Figure 11: UTK 600 dimensions	29
Figure 12: transport on pallet.....	30
Figure 13: lifting off the pallet	30
Figure 14: levelling via the feet.....	31
Figure 15: working positions.....	33
Figure 16: terminal box.....	34
Figure 17: direction of rotation	34
Figure 18: suction nozzles UTK 500 and 600.....	35
Figure 19: earthing example for suction hose	35
Figure 20: connector.....	35
Figure 21: maintenance unit.....	36
Figure 22: components and controls	37
Figure 23: control panel with switches and signal lamps.....	38
Figure 24: two-hand safety control	39
Figure 25: adjusting knob for lifting speed	39
Figure 26: safety switch UTK 600 - door unlocked.....	40
Figure 27: safety switch UTK 600 - door locked.....	40
Figure 28: vertically mounted safety switch	40
Figure 29: saw blade disassembly via expansion cone flange.....	41
Figure 30: direction of rotation of the saw blade	41
Figure 31: clamping guard for model UTK 600	42
Figure 32: clamping guard for model UTK 350	42
Figure 33: protective shield (standard version)	42
Figure 34: optional pneumatic protective shield	43
Figure 35: full protection cover with viewing window.....	43
Figure 36: workpiece fence.....	43
Figure 37: inclined machine design.....	44
Figure 38: pneumatic horizontal clamping device	44
Figure 39: roller conveyor mounted on one side.....	44
Figure 40: saw blade access door	45
Figure 41: adjustment knob for lifting speed.....	45
Figure 42: manual positioning system with flip stop	45
Figure 43: cut triggering via two-hand control	46
Figure 44: laser unit to indicate the cutting line	47
Figure 45: visualisation of the cutting line on the workpiece	47
Figure 46: wear rail in the state of delivery (example UTK 600)	52
Figure 47: wear rail in the fitted state, still without slot (example UTK 600)	52
Figure 48: ready-to-use wear rail with sawn slot (example UTK 600).....	52
Figure 49: motor cover plate removed.....	53
Figure 50: V-belt tensioning nuts UTK 350	53
Figure 51: V-belt tensioning nuts UTK 450	53
Figure 52: V-belt tensioning nuts UTK 500	54
Figure 53: V-belt tensioning nuts UTK 600	54
Figure 54: brake adjustment screw 2.2 / 3.0 / 4.0 kW	56
Figure 55: brake adjustment screw 5.5 / 7.5 kW	56

Revisions:

Revision	Editor	Modification	Date
001	AG	Original manual translated	08/05/2023
002	AG	Section ⇨ 12.3.1 extended with additional error numbers of the new PLC.	14/03/2024

1 Liability and warranty

When purchasing a machine or work equipment (hereinafter referred to as “machine”), the General Terms and Conditions of Sale and Delivery of Reinhold Beck Maschinenbau GmbH generally apply. These are provided to the purchaser or operator at the latest when the contract is concluded.



IMPORTANT NOTE: Liability and warranty claims shall only commence from the point in time at which the signed handover certificate (see ⇒ page 3 resp. page 5) from the dealer and/or end customer for the delivered machine has been submitted to Reinhold Beck Maschinenbau GmbH in written form.

Liability and warranty claims for personal injury and property damage are generally excluded if they are due to one or more of the following causes:

- Commissioning of the machine without prior machine instruction by an authorised and adequately trained specialist who is familiar with the function and dangers of the machine.
- Electrical connection as well as repair and/or maintenance work on electrical components by personnel who do not have the appropriate qualifications.
- Connection and repair and/or maintenance work on hydraulic or pneumatic components by personnel who do not have the appropriate qualifications.
- Non-observance of the instructions in the operating manual, in particular the chapter “Safety”.
- Improper use or operation in an unauthorised area of application.
- Improper assembly, commissioning, operation and maintenance of the machine.
- Unauthorised conversions or modifications to the machine or additional components.
- Operating the machine without using all the protective equipment available for the operation.
- Inadequate monitoring and maintenance of the machine components and protective devices.
- Continuing to operate the machine when faults, damage or defects are present.
- Processing materials that do not correspond to the machine's area of application.
- Carrying out operations that are not permitted for the machine supplied.
- Use of tools that are not permitted for the machine supplied.
- Operating the machine outdoors or in damp, wet or potentially explosive environments.
- Operation of the machine outside permissible ambient temperatures or humidity.
- Grossly negligent behaviour when handling or operating the machine.
- Impact by foreign bodies, e.g. stones, metal parts, etc.
- Improperly carried out repairs.
- Catastrophic events due to force majeure.

2 Introduction

The purpose of this document is to acquaint the user with the machine and enable him to use it to the full extent of its intended capabilities. Additionally it contains important information to operate the machine safely, properly and economically.

Observance of the manual helps to avoid hazards, reduce repair costs and downtimes and increase the reliability and service life of the machine. Furthermore, this operating manual serves to supplement instructions based on national regulations for accident prevention and environmental protection.

	<p><i>This operating manual must always be available at the place of use of the machine. It must be read and followed by every person who is assigned to work on the machine, e.g.</i></p> <ul style="list-style-type: none"> • <i>during operation, including set-up, troubleshooting in the work process, removal of production waste and maintenance,</i> • <i>during maintenance (servicing, inspection, repair)</i> • <i>and/or during transport.)</i>
---	---

Apart from the operating manual and the legally binding accident prevention provisions applicable in the country and place of use, the recognized technical regulations for safe and proper work must also be observed.

2.1 Legal notice



All contents of these operating instructions are subject to the rights of use and copyright of Reinhold Beck Maschinenbau GmbH. Any reproduction, modification, further use and publication in other electronic or printed media, as well as their online publication, requires the prior written consent of Reinhold Beck Maschinenbau GmbH.

2.2 Illustrations

All photos, figures and graphics contained in this document are for illustration and better understanding only and may differ from the current state of the product.

3 Symbols

3.1 General Symbols

Symbol	Meaning
	Indicates passages within this operating manual that must be particularly observed in order to prevent malfunctions or damage to the machine.
	Refers to chapters, sections, or figures within this document.
	Refers to an external document or a third-party source.

3.2 Symbols in safety instructions

Symbol	Safety instruction
	General danger symbol, which requires the highest attention! <i>Failure to observe may result in damage to the equipment, serious injury or even death.</i>
	Warning of possible danger from forklift traffic! <i>Non-observance may result in life-threatening injuries.</i>
	Warning indicates a possible hazard under suspended loads! <i>Non-observance may result in life-threatening injuries.</i>
	Warning indicates a possible fall hazard! <i>Non-observance of these instructions may result in serious injuries.</i>
	Warning indicates a possible cutting hazard! <i>Risk of personal injury and possibly additional damage to equipment.</i>
	Reference to the obligation to wear protective gloves! <i>Non-observance of these instructions may result in personal injury.</i>
	Reference to the obligation to wear hearing protection! <i>Non-observance of these instructions may result in personal injury.</i>
	Reference to the obligation to wear protective goggles! <i>Non-observance of these instructions may result in personal injury.</i>
	Reference to the obligation to wear a respiratory protection mask! <i>Non-observance of these instructions may cause breathing difficulties and lung damage.</i>
	Reference to the obligation to wear safety shoes! <i>Non-observance of these instructions may result in personal injury.</i>
	Possible dangerous crushing hazard in the area of stationary objects! <i>Risk of personal injury and possibly additional equipment damage.</i>
	Reference to a possible crushing hazard! <i>Non-observance increases the risk of injury to hands and fingers!</i>
	Reference to a possible danger due to ejecting parts! <i>Danger of life-threatening personal injury and possibly additional damage to property.</i>
	Reference to a possible danger of impact! <i>Danger of life-threatening personal injury and possibly additional damage to property.</i>
	This symbol warns of the dangers of electric voltage! <i>Failure to observe may result in damage to the equipment, serious injury or even death.</i>
	Fire hazard! Do not smoke and do not ignite open fire.
	Access for unauthorized persons prohibited! <i>Risk of personal injury and possibly additional equipment damage.</i>
	This safety notice indicates a possible dangerous pull-in hazard! Wearing loose clothing, jewellery as well as long untied hair is prohibited! <i>Risk of personal injury and possibly additional damage to property.</i>

4 General

This under-table cross-cut saw was produced by Beck Maschinenbau GmbH according to the current state of the art and placed on the market as a complete machine. All legal and normative regulations have been complied with.

The four models are designed for different saw blade diameters (350, 450, 500 and 600 mm). In addition to a solid machine body made of stable, welded steel cements, the sophisticated technology contributes to making work safe and economical.

The pneumatic drive for the saw stroke and the automatic fixing of the workpieces are part of the extensive standard equipment.



Figure 1: machining process on the UTK

For even more efficient work processes, the machines can be combined with manually or electronically controlled roller and measuring conveyors as well as length stop systems from the extensive product portfolio of Reinhold Beck Maschinenbau GmbH. These are available in various configurations and lengths.



Important note: According to CE regulations, an additional work table (optionally with or without castors) is required for the operation of the machine!

4.1 Structure and function

- The machine body is manufactured in a shapely and stable welded steel construction.
- The saw unit is equipped with robust bearings.
- The large, wide-opening access door enables a quick and easy saw blade change.
- The saw stroke is pneumatic and the lifting speed is infinitely variable.
The lifting cylinder is also equipped with an end position damping system.
- The cutting stroke for the circular saw blade is triggered via a Two-hand safety control.
- The workpiece is clamped by the pneumatic guard before each cutting stroke.
- The safety of access to the raised circular saw blade is ensured, among other things, by a protective shield in front of the cutting plane. After the cut, the saw blade automatically returns to its original position under the machine table.
- In the area of the saw blade, the machine table is equipped with replaceable wear rails.
- The electrical switching is done via a rotary cam switch
(for 2.2 kW motors with direct starting, for motors from 3 kW with star/delta starting).

4.2 Standard equipment

- Main switch and emergency stop button
- Start/stop button combination
- Automatic motor brake
- Pneumatic connection with pressure regulating valve and maintenance unit
- Machine table with workpiece fence
- Workpiece clamping during cutting by pneumatically operated guard
- Infinitely variable lifting speed
- Protective shield as access protection to the saw blade during the cut
- Machine installation with levelling feet
- Depending on the model, two or three suction connections (for number and \varnothing see section ⇒ 6.1)
- Set of operating keys
- CE-compliant design

4.3 Available optional accessories

The under-table cross-cut saw is prepared for the later attachment of special accessories from the extensive range of Reinhold Beck Maschinenbau GmbH.

- Circular saw blades in suitable size for all models
- Two horizontal clamps with pneumatic actuation¹
- Full protection cover for the entire cutting area
- Laser device for precise indication of the cutting line
- Spraying device (micro cooler) for cutting aluminium
- UTK 350 and UTK 450 only: Machine in 10° inclined design, for easier positioning of workpieces to the workpiece fence
- UTK 500 and UTK 600 only: Unhindered feeding and positioning of workpieces by means of a pneumatically operated protective shield that can be raised and lowered¹
- UTK 500 and UTK 600 only: Pneumatic stroke with oil brake cylinder (feed brake) - for light metal
- Roller and measuring conveyors "EXAKT", manually or electronically controlled, refer to <https://beck-maschinenbau.com/en/products/roller-measuring-conveyors/>

The article numbers for special accessories and optional components can be found in the chapter ⇒ 14.

For the subsequent extension of your machine, documents on the desired special accessories can be requested. Please send your enquiry directly to the machine manufacturer, stating the data on the name plate of your machine.

4.4 Target group and previous experience

This operating manual is intended for the operating and maintenance personnel of the machine. The operating personnel is to be determined by the operator and must further meet the following requirements:

- Basic technical knowledge (e.g. apprenticeship as carpenter, machine fitter, etc. and/or practice in operating woodworking machines)
- Reading and understanding these operating and maintenance instructions

In order to acquire the knowledge required to operate this machine, the operator must ensure the following measures:

- Product training for every operator (also possible external personnel)
- Regular safety instruction

4.5 Training of the personnel

All machine operators must be adequately trained in the operation and maintenance of the crosscut saw. The respective supervisors are responsible for the training of the personnel who are assigned to work on the machine. In detail, the training must include the following:

- General rules for using the machine, proper operation, correct setting of the under-table cross-cut saw, workpiece fences and all safety and protective devices.
- Proper handling of the workpieces during the machining process.
- The personnel must be informed about hazards, risks and appropriate protective measures.
- The personnel must be trained in the area of regular checks of the protective devices.
- Personnel must be trained in the use of protective devices.
- Personnel must understand and comply with the applicable safety regulations.
- The training must also include operating instructions and instruction on the handling of hazardous substances (wood dust, etc.) and other existing hazards.

¹ The pneumatic horizontal clamps and the pneumatic safety shield cannot be combined with each other.

4.6 Requirements for the Operators

- The under-table cross-cut saw may only be operated by trained personnel who have also read this manual.
- Inspection, maintenance, cleaning and repair may only be performed by technical specialists with product-specific training and mechanical and/or electrical training.
- Specialists with product-specific training are to be commissioned and held responsible for planning and checking the work.
- The national protective regulations for employees must be observed .
- The operator is responsible for the safe use of the machine.
- The legal minimum age must be observed.

4.7 Accident Prevention

To avoid accidents, the following rules must be observed for operation:

- Prevent unauthorized persons from gaining access to the machine.
- Consider the instructions in section ⇒ 5.4 “Hazardous areas of the under-table cross-cut saw”.
- Keep unauthorized persons away from the danger areas.
- Repeatedly inform present other persons about existing residual risks (see section ⇒ 5.1.9).
- Conduct and record regular training & instruction for persons who must be in the area of the machine.
- New employees must be trained internally to work on a thickener and this training must be documented.

4.8 General Safety Regulations

In general, the following safety regulations and obligations apply when using the under-table cross-cut saw:

- An under-table cross-cut saw may only be operated when it is in perfect and clean condition.
- It is forbidden to remove, change or bypass any protective, safety or monitoring equipment.
- It is forbidden to modify or change the under-table cross-cut saw without the written approval of the manufacturer / supplier.
- Malfunctions or damage must be reported to the operator immediately. These must be rectified immediately and repaired if necessary.
- Only original spare parts may be used for repairs.
- All protective, safety and monitoring equipment must be regularly checked and maintained by the operator.
- Only instructed, trained or qualified persons may work on this machine.
- Maintenance work must be carried out and documented in accordance with the maintenance instructions.
- After maintenance or repair, the machine may only be started with all protective devices fitted. A responsible person must be defined for this purpose who checks that the guards are properly fitted.
- For the operation of an under-table cross-cut saw, the respective national protective regulations for workers as well as the national safety and accident prevention regulations apply.

5 Safety

5.1 Basic safety instructions

Woodworking machines can be dangerous if used improperly. Therefore, observe the safety instructions listed in this chapter and the accident prevention regulations of your employer's liability insurance association!



The manufacturer accepts no liability for damage and malfunctions resulting from failure to observe these operating instructions.

The under-table cross-cut saw includes all safety devices resulting from the regulations, the standards, the accident prevention regulations and the state of technology.

5.1.1 Area of application and intended use



The machine may only be operated on a level, firm surface with a minimum load-bearing capacity of 1,000 kg/m².



Improper use can lead to danger to persons and to a defect or damage to the machine.

The four under-table cross-cut saws UTK 350, UTK 450, UTK 500, UTK 600 are used exclusively for cutting solid wood and wood-like materials to length.

Cutting solid wood to length refers to the process of **cutting across the grain**.



Any processing of other materials requires prior consultation with Reinhold Beck Maschinenbau GmbH and their express consent.

Intended use also includes connection of the machine to an adequately dimensioned extraction system and compliance with the operating, maintenance and servicing conditions specified in this operating manual.

Any other use is considered improper and is prohibited.

5.1.2 Prohibition of misuse

The information on intended use given in the previous section must be strictly adhered to. Any other use of the under-table cross-cut saw is considered improper and therefore prohibited.

5.1.3 Environmental conditions

The machine is not suitable for operation outdoors or in potentially explosive atmospheres.

- permissible ambient temperature: +5 to +40° C.
- permissible operating height: max. 1000 m above sea level.
- permissible humidity: max. 90 %

5.1.4 Modifications and conversions to the machine



Unauthorised conversions and modifications to the machine are strictly prohibited for safety reasons. This will invalidate the CE declaration of conformity! The manufacturer is not liable for any resulting damage. The risk for this is borne exclusively by the operator/user.

5.1.5 Permissible workpiece cross-sections

Solid wood may only be processed with the under-table cross-cut saw if the cross-section dimensions of the respective UTK model or saw blade diameter correspond to the following ranges:

UTK 350:

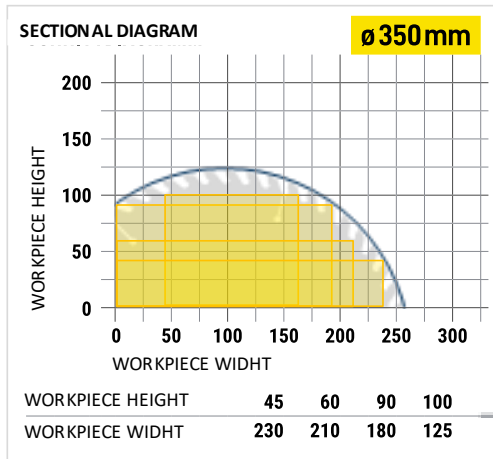

Figure 2: permissible workpiece cross-sections UTK 350

UTK 450:

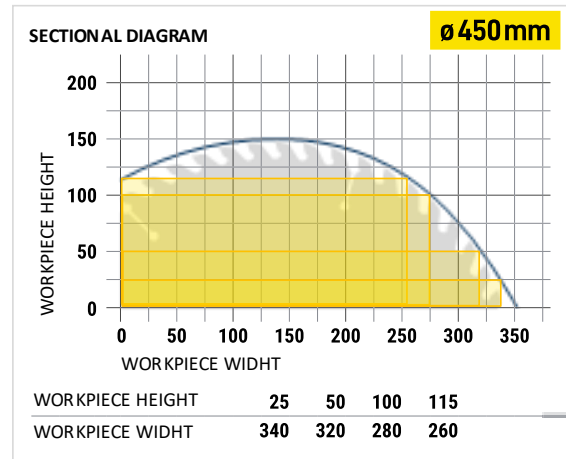
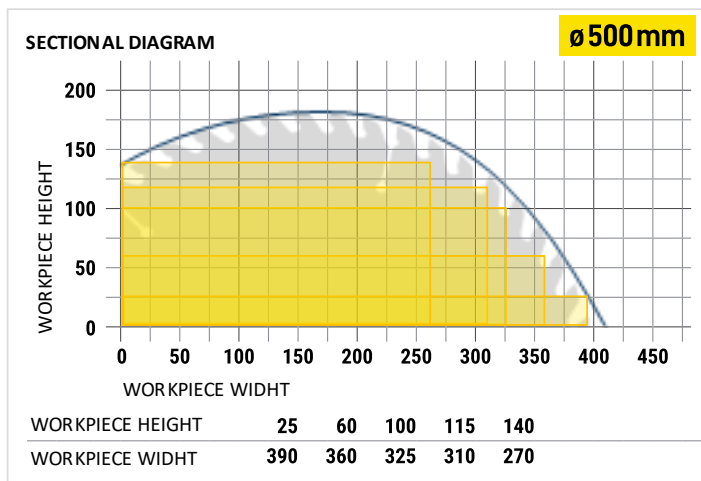

Figure 3: permissible workpiece cross-sections UTK 450

UTK 500:



Note: All dimensions in millimetres

Figure 4: permissible workpiece cross-sections UTK 500

UTK600:

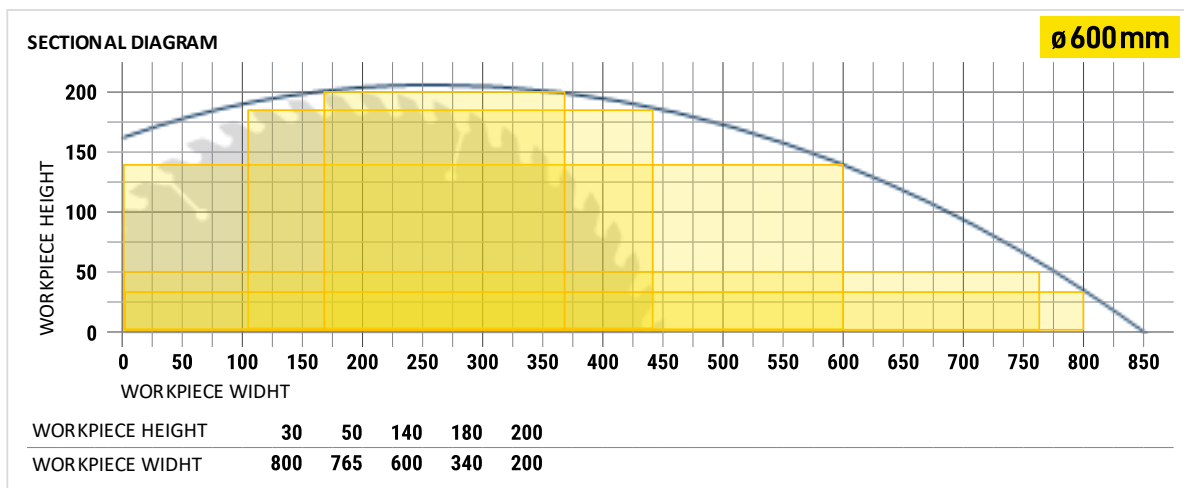



Figure 5: permissible workpiece cross-sections UTK 600

5.1.6 Machinable workpiece lengths

Only workpieces that can be safely placed on the machine table and positioned at the workpiece fence for cutting to length may be processed. The workpiece length must generally be selected in such a way that dangerous tipping and falling down is prevented. Therefore, the infeed and/or outfeed side must be extended with an additional work table or with roller resp. measuring conveyors.

 **Important note: According to CE regulations, an additional work table (optionally with or without castors) is required for the operation of the machine!**

A wide range of manually or electronically controlled roller and measuring conveyors can be found in our product catalogue, see download on <https://beck-maschinenbau.com/en/products/roller-measuring-conveyors/>.

5.1.7 Usable circular saw blades

- Workpiece machining is to be carried out with carbide-tipped circular saw blades.
- The decisive factor here is the suitability for machining across the grain.

The following circular saw blades are to be used for the four UTK models:

<i>Model</i>	<i>UTK 350</i>	<i>UTK 450</i>	<i>UTK 500</i>	<i>UTK 600</i>
Circular saw blade	Ø 350 mm	Ø 450 mm	Ø 500 mm	Ø 600 mm

 **Do not use circular saw blades whose maximum speed is lower than the saw shaft speed of the machine.**

 **Only circular saw blades manufactured in accordance with the European standard EN 847-1 may be used.**

 **Only use circular saw blades that are well sharpened and undamaged. A defective or damaged circular saw blade must be replaced immediately with a new one.**

























Suitable circular saw blades for your machine can be found in chapter ⇒ 14 “Options and accessories”.









5.1.8 Working areas at the machine

- The machine is designed to be operated by a single person
- Cutting to length with the under-table cross-cut saw must always be carried out from the working area in front of the operating elements resp. in front of the Two-hand safety control.
- For details on the working areas, see section ⇒ 8.6 “Workplace requirements”.

5.1.9 Residual risks

The machine is built according to the latest state of the art and the recognised safety rules. Nevertheless, the use of the machine may cause danger to life and limb of the user or third parties or damage to the machine and other equipment. Due to the construction of the machine, the following residual risks can occur even when used as intended and despite compliance with all relevant safety regulations:

	Reading and applying the operating manual is mandatory for the operating personnel.
	Be alert to possible crushing hazards: a) when transporting the machine by forklift truck → between forks & pallet / machine b) when picking up the machine → between machine / pallet and floor c) when lowering the machine → between machine and fixed equipment
	Be alert to possible crushing hazards when lowering the machine (from the cargo pallet to the floor) with a forklift truck or overhead crane.
	Make sure that no objects fall from the forklift truck / crane. Do not leave any objects / tools on the machine.
	It is strictly prohibited to ride on the machine during a lifting operation (with the indoor crane or forklift). There is a danger of falling!
	Unauthorised persons are not allowed to enter the installation area of the machine (responsibility of the operator).
	Be aware of possible tripping and slipping hazards on the floor. Prevent possible hazards by keeping the floor dry and clean and by using anti-slip floor coverings around the machine.
 	Be aware of the danger from falling objects such as workpieces, tools or similar. Therefore, wear safety shoes, especially when transporting and setting down the machine.
 	The protective shield on the operating side must not be removed under any circumstances! Cutting without the protective shield is prohibited. The wearing of protective goggles is mandatory.
 	Pay attention to the existing cutting hazard on the circular saw blade. Never reach into the running saw blade! Only change the saw blade when wearing protective gloves.
	Be aware of the danger of snow from chips and splinters and never remove them from the danger area by hand. Use suitable aids, e.g. hand brushes.
 	Danger of being drawn in! Do not clean the circular saw blade with a brush or scraper held in your hand while the machine is running.
	Watch out for a possible danger of being drawn in by moving machine parts or tools, especially on the circular saw blade. This can cause pieces of clothing or hair to be caught. Always wear tight-fitting clothing resp. avoid loose clothing and wear a hair net if necessary. Wearing watches, jewellery and scarves on the machine is prohibited!
	Danger from electric shock! There are hazards when working on the electrical system. This work must only be carried out by qualified personnel!
	Danger from electric shock! It is strictly forbidden to bypass safety devices (e.g. safety switches).
 	Electrical equipment must be maintained and cleaned regularly.
	Pay attention to the danger of crushing on workpiece guides and moving machine parts.
	When clamping the workpiece with the pneumatic guard, be aware of the existing risk of crushing between the workpiece and the pneumatic guard.
	During machining, pay attention to the existing danger of crushing between the workpiece and fixed parts of the machine.

	Make sure that no unauthorised persons are in the area of the machine.
	Be aware of the risk of injury from flying tool parts in the event of tool breakage. Therefore wear protective goggles.
	Be aware of the risk of injury from flying workpiece parts and chips, splinters and dust coming out of the machine. Therefore wear protective goggles.
	Be aware of the increased noise emission and wear hearing protection.
	Be aware of the increased dust generation. Use the extraction system and wear a dust mask if necessary.
	The emergency stop button must always be freely accessible and must not be blocked. Check the function of the emergency stop button daily (before using the machine).
	Be aware of the dangers that can occur when working with compressed air.
	Laser warning: The machine can be optionally equipped with a laser cutting line indicator. Looking directly into the laser beam will cause serious eye injuries!
	Fire hazard due to wood dust in connection with flying sparks and/or open fire!









Also pay particular attention to the hazardous areas listed in section ⇒ 5.4.

5.1.10 Observe the environmental protection regulations

During all work with the machine, the environmental protection regulations, obligations and laws for waste avoidance and proper recycling and/or disposal applicable at the place of use must be observed. This applies in particular to installation, repair and maintenance work involving substances that could pollute the groundwater (e.g. hydraulic oils and cleaning agents and liquids containing solvents). In any case, prevent them from seeping into the ground or entering the sewage system.

	Store and transport the above-mentioned hazardous substances only in suitable containers. Avoid leakage of hazardous substances by using suitable collection containers. Ensure that the above-mentioned substances are disposed of by a qualified disposal company.
---	---

5.1.11 Organisational measures

-  Always keep this operating manual within easy reach and at the place of use of the machine.
-  In addition to the operating manual, observe and instruct on generally applicable legal and other binding regulations for accident prevention and environmental protection.
-  Supplement the operating manual with further instructions, including supervisory and reporting duties, to take account of special operational features (e.g. with regard to work organisation, work processes, personnel employed).
-  Before starting work on the machine, the person responsible for its operation must have read the operating instructions, especially the chapter ⇒ 5 “Safety”. It is too late during work! This applies in particular to personnel who only occasionally work on the machine, e.g. during set-up or maintenance.
-  Check that work is carried out in a safety-conscious and hazard-conscious manner and in compliance with the operating manual.
-  Operators must not wear open long hair, loose clothing or jewellery (including rings). There is a risk of injury, e.g. by getting caught or drawn in.
-  Observe the safety instructions and danger warnings on the machine and keep them complete and in legible condition.
-  In case of safety-relevant changes to the machine or its operating behaviour, shut down the entire system immediately and report the fault to the responsible office/person.

- ⚠ Use personal protective equipment as necessary or required by regulations.
- ⚠ Do not make any modifications, additional attachments or conversions to the machine without the manufacturer's approval! This will compromise safety and invalidate the manufacturer's warranty and any liability claim. The same also applies to the installation and adjustment of safety devices and valves and to welding work on load-bearing part.
- ⚠ Spare parts must meet the technical requirements specified by the manufacturer. The exclusive use of original spare parts ensures this. Therefore, only use original spare parts from the manufacturer.
- ⚠ Observe the fire alarm and firefighting possibilities. Make the location and operation of fire extinguishers (fire class ABC) known. Do not use water!

5.1.12 Personnel selection and qualification - basic duties



- ⚠ The machine design and operation is intended for right-handers.
- ⚠ The machine is intended for operation by a single person. Other persons in the vicinity of the machine must maintain an appropriate safety distance.
- ⚠ Work on the machine may only be carried out by reliable personnel. Observe the legal minimum age!
- ⚠ Only use trained or instructed personnel. Clearly define the responsibilities of the personnel for operating, setting up, maintaining and repairing!
- ⚠ Ensure that only authorised personnel work on the machine!
- ⚠ Only allow personnel to be trained, instructed or undergoing general training to work on the machine under the constant supervision of an experienced person.
- ⚠ Work on pneumatic equipment may only be carried out by qualified personnel.
- ⚠ Work on the electrical equipment of the machine may only be carried out by a qualified electrician or by untrained persons under the direction and supervision of a qualified electrician in accordance with the electrotechnical regulations.

5.2 Existing safety equipment

The machine is equipped with all necessary safety devices. These include:

- The main switch (⇒ 10.1) can be padlocked to prevent unauthorised activation when the machine is not in use or during adjustment, maintenance and repair work.
- The under-table cross-cut saw has an emergency stop button (⇒ 10.1) on the operating side to stop the saw in an emergency or dangerous situation.
- Safety pressure device: The pneumatically operated guard (⇒ 11.1) automatically lowers to clamp the workpieces when a cut is triggered. Thus the danger zone above the circular saw blade is effectively covered during the sawing process.
- The Two-hand safety control (⇒ 10.3) mounted on the operator's side to initiate the cut ensures that the operator cannot place any hand in the danger zone of the circular saw blade during a cut.
- From the operator's side, the circular saw blade and the danger areas listed in section ⇒ 5.4 are covered by a protective shield.
- A sufficient compressed air supply is ensured by an internal safety circuit and a blue indicator light (⇒ 10.1). As soon as the compressed air supply is missing or insufficient, the blue control lamp lights up and the saw blade drive cannot be started until the compressed air supply is restored and the error has been acknowledged by pressing the blue illuminated push button.
- To open the access door to the circular saw blade, the safety switch (⇒ 10.6) mounted in front of the access door must first be unlocked manually using a knurled screw. Once the safety switch is unlocked, the machine can no longer be started.
- The integrated safety PLC ensures safe behaviour of the machine and existing components in the event of malfunctions, irregularities and unintended interruptions. These are indicated by the white signal lamp in the control panel by various flashing sequences (⇒ 12.3).

5.3 Safety instructions for specific phases of operation

	Defects and damage to the machine are to be reported immediately after detection.
	Any mode of operation that compromises safety is prohibited!
	Sufficient lighting (at least 500 lux) around the machine must be ensured!

5.3.1 Before starting work

- Protective equipment:** Wear personal protective equipment (safety goggles, safety shoes, ear protection, dust mask) and close-fitting clothing and, if necessary, a hair net! Take off watches, necklaces and other jewellery.



- Machine condition:** Only operate the machine when it is in working order and in a safe condition. Before starting work on the machine, check the machine at least once per shift for externally visible damage and defects. Report any changes that have occurred (including changes in operating behaviour) immediately to the responsible office or person. If necessary, stop the machine immediately and secure the machine against unauthorised activation.
- Extraction:** The machine must be connected to an effective extraction system before initial start-up. This requires a flow rate of at least 20 m/s for dry chips and 28 m/s for moist chips (18 % moisture or more).
- Workpiece support:** Before starting sawing work, clean the workpiece support surfaces of the machine table, the workpiece fence and the workpiece support surfaces of optionally used tables, roller or measuring conveyors. Remove all objects and tools from the support surfaces.
- Workpiece handling:** If protective gloves are required for workpiece handling by the operator or called-in assistants, they must be tight-fitting.
- Tools:** Only use a circular saw blade suitable for the respective operation and material.
- Tool condition:** Check the condition of the circular saw blade before starting work. Only use saw blades that are well sharpened and undamaged. A damaged or defective saw blade must be replaced immediately!
- Table insert:** Also check the condition of the wear rail (⇒ 13.3) surrounding the circular saw blade. Replace a defective, damaged or frayed table insert immediately. The same applies if the gap between the table insert and the saw blade is so large that chips and dirt can penetrate.
- Floor condition:** The floor must be level, sufficiently non-slip and free of debris. Keep the floor in the area of movement around the machine free of tripping hazards.
- Lighting:** The working area must be sufficiently illuminated by local lighting.
- Changing the saw blade:** Only change the saw blade when wearing protective gloves.
- Waste pieces:** Provide containers for waste pieces.

5.3.2 Normal operation

- ⚠ **Guards:** Take measures to ensure that the machine can only be operated in a safe and functional condition. Only operate the machine when all guards and safety-related devices such as

 - detachable guards,
 - emergency stop devices,
 - noise insulations,
 - extraction system

are available and functional

All available protective equipment must always be used during work.
- ⚠ **Workpiece:** Before the operation, check the workpiece for

 - foreign inclusions
 - knots
 - twists (contortions)

and other irregularities.
- ⚠ **Sawing operation:** Do not start sawing until the circular saw blade has reached full speed.
- ⚠ **Workpiece infeed:** The workpiece can be fed manually or via an electromotive length stop system. Ensure good workpiece support for long workpieces. Use appropriate table extensions (e.g. measuring or roller conveyors) for workpieces which, due to their dimensions, cannot rest safely on the support surfaces of the infeed and outfeed side. This effectively prevents dangerous tipping or falling. Do not process unshaped workpieces that cannot be placed safely on the machine table due to their surface properties!
- ⚠ **Workpiece fence:** To avoid workpiece kickbacks and associated hazards, always push the workpiece completely against the workpiece fence so that it rests well against the fence plate. This also prevents slanted cuts and/or inaccurate cutting results.
- ⚠ **Cutting dimension:** Set the desired cutting dimension with a suitable measuring device or via a length stop system (e.g. manually or electronically controlled roller resp. measuring conveyors).
- ⚠ **Workpiece clamping:** The workpiece to be machined is automatically clamped against the machine table from above via the pneumatic guard when the cut is triggered via the Two-hand safety control. Do not clamp any non-shaped workpieces that cannot be safely clamped by the pneumatic guard due to their surface properties!
- ⚠ **Horizontal workpiece clamping:** With the optional pneumatically operated horizontal clamping device, the workpieces can also be clamped horizontally against the workpiece fence.
- ⚠ **Sawing area during operation:** Never try to remove splinters, chips or other parts from the sawing area while the machine is running! Never remove splinters and chips by hand!
- ⚠ **Two-hand safety control:** A cutting stroke may only be triggered by a single person and exclusively via the Two-hand safety control.
- ⚠ **Assistance staff:** If other persons are called in, for example to feed unmachined workpieces via an optional roller or measuring conveyors or to remove finished workpieces, they may only be at the "assistant" working positions (see ⇒ Figure 15), but not in the immediate vicinity of the under-table cross-cut saw.
- ⚠ **Braking time after switching off:** The under-table cross-cut saw is equipped with a mechanical motor brake. If the brake no longer brakes within the prescribed braking time (within 10 seconds), it must be readjusted (see ⇒ 13.6). If necessary, inform the customer service.
- ⚠ **Work interruptions:** Generally switch off the under-table cross-cut saw even during short interruptions of work! Never leave the machine running unattended! For longer interruptions, proceed as described in the next point "Leaving the machine".
- ⚠ **Leaving the machine:** Before leaving the machine, switch off the main switch and wait for the machine to stop. Lock the main switch with a padlock! Never leave the machine unattended and unsecured.

5.3.3 Special work within the scope of maintenance work as well as troubleshooting in the workflow

- ⚠ Observe maintenance and inspection activities prescribed in chapter ⇒ 13 “Maintenance and inspection”!
- ⚠ These activities, as well as all other repair work, may only be carried out by qualified personnel!
- ⚠ For all work concerning operation, production adjustment, conversion or setting of the machine and its safety-related equipment as well as maintenance and repair, observe switch-on and switch-off procedures according to the operating manual and instructions for maintenance work!
- ⚠ Secure the machine against unexpected restarting during maintenance and repair work.
 - **Lock the main switch with a padlock!**
- ⚠ Always tighten screw connections that have been loosened during maintenance and repair work!
- ⚠ If it is necessary to dismantle safety equipment during set-up, maintenance and repair, the safety equipment must be reassembled and checked immediately after completion of the maintenance and repair work!
- ⚠ Ensure safe and environmentally friendly disposal of operating and auxiliary materials (e.g. oils) and replacement parts (e.g. electronic components)! Refer to chapter ⇒ 15 “Disassembly and Scrapping”.

5.4 Hazardous areas on the under-table cross-cut saw

Various hazards can arise on the under-table cross-cut saw. Particular attention must be paid to the danger areas listed in this section. Here, there is an acute potential for danger ranging from minor and serious injuries to fatalities!

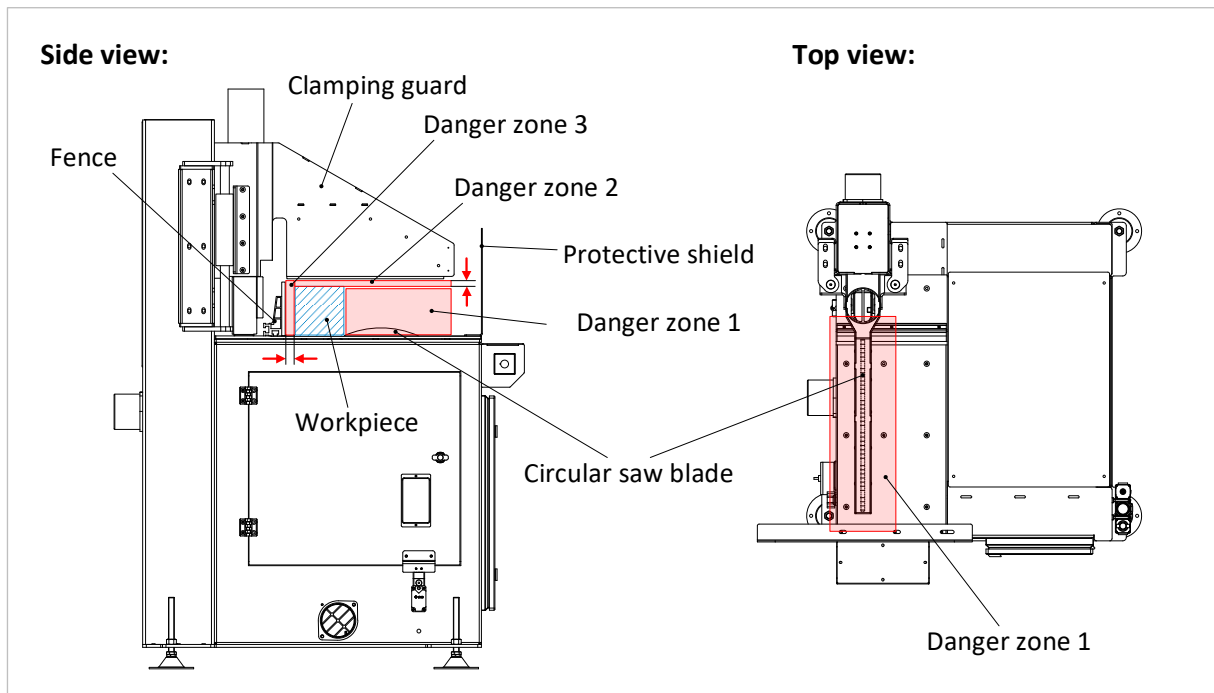





Figure 6: danger zones on the under-table cross-cut saw

<p>Danger zone 1</p> 	<p>→ Cutting hazard and danger of being drawn in when the saw blade is running</p> <ul style="list-style-type: none"> • Acute danger of being drawn in and cut 120 mm around the circular saw blade. • Never reach into this area with your hands when the machine is running! • The protective shield must never be removed, never work without a protective shield! • Watches, jewellery, scarves, loose clothing etc. as well as loose hair are prohibited! • Only change the saw blade when wearing protective gloves.
<p>Danger zone 2</p> 	<p>→ Danger of crushing between clamping guard and workpiece</p> <ul style="list-style-type: none"> • Acute danger of crushing when clamping with the pneumatic clamping guard. • Never reach into this area with your hands when clamping the workpiece!
<p>Danger zone 3</p> 	<p>→ Danger of crushing between workpiece and fence</p> <ul style="list-style-type: none"> • Danger of crushing when placing workpieces against the workpiece fence! • Keep hands out of this area when placing the workpiece! • There is an even more acute risk of crushing, especially when using a pneumatically operated horizontal clamping device (available as an option). • Never reach into this area with your hands when clamping the workpiece!

Other hazardous areas:

<p>Noise and dust</p> 	<p>→ Around the machine due to the noise and dust generated</p> <ul style="list-style-type: none"> • Be aware of the increased noise level and wear hearing protection. • Be aware of increased dust generation and generally use an extraction system. Wear a dust mask if necessary.
--	---

Please note the supplementary information on all other possible hazards in section ⇨ 5.1.9 “Residual risks”.

6 Machine data

6.1 Technical specifications

<i>Model</i>	<i>UTK 350</i>	<i>UTK 450</i>	<i>UTK 500</i>	<i>UTK 600</i>
Maximum cutting height	100 mm	115 mm	140 mm	200 mm
Maximum cutting width	230 mm	340 mm	390 mm	800 mm
Circular saw blade	Ø 350 mm	Ø 450 mm	Ø 500 mm	Ø 600 mm
Saw blade bore	Ø 30 mm	Ø 30 mm	Ø 30 mm	Ø 35 mm
Sawing motor (standard)	2.2 kW / 3 HP	3 kW / 4 HP	5.5 kW / 7.5 HP	7.5 kW / 10 HP
Saw blade speed	3800 rpm	2900 rpm	2800 rpm	2800 rpm
Lifting speed	13 - 375 mm/s (infinitely variable)			
Air consumption per saw cycle	approx. 5 L	approx. 8 L	approx. 8 L	approx. 20 L
Operating pressure	7 - 8 bar	7 - 8 bar	7 - 8 bar	7 - 8 bar
Suction nozzles [Qty + Ø in mm]	2 x 100	1 x 100 + 1 x 120	3 x 100	1 x 100 + 2 x 120
Recommended total connection	Ø 140 mm	Ø 160 mm	Ø 160 mm	Ø 200 mm
Minimum volume flow at 20 m/s	1.110 m ³ /h	1.440 m ³ /h	1.440 m ³ /h	2.260 m ³ /h
Air velocity at the port	min. 20 m/s			
Negative pressure at the port	approx. 1.200 Pa at 20 m/s			
Electrical voltage	400 V / 50 Hz / 3 phases			
Recommended supply cable	Type H07RN F (for details refer to section ⇒ 8.7.1)			
Weight	approx. 200 kg	approx. 250 kg	approx. 400 kg	approx. 520 kg
Dimensions	see dimensional drawings in chapter ⇒ 6.2.3			



R. Beck Maschinenbau GmbH
Im Grund 23
D-72505 Krauchenwies
☎ +49(0)7576 962978-0
www.beck-maschinenbau.de

Under-table cross-cut saw 

Baureihe line	
Typ type	UTK
Maschinen-Nr. machine no.	
Baujahr year of construction	202
Bemessungsspannung U = nominal voltage U =	V
Frequenz/Phasenzahl frequency/phases	Hz / 3
Stromart kind of current	AC
Vollaststrom I = operating current I =	A
Überstromschutz, extern excess current protection, external	A

Figure 7: name plate

Manufacturer:

Reinhold Beck Maschinenbau GmbH
Im Grund 23
72505 Krauchenwies (Germany)
Telefon: +49 (0) 7576 / 962 978 - 0
Telefax: +49 (0) 7576 / 962 978 - 90
Email: info@beck-maschinenbau.de

Correspondence in case of service

In case of technical problems, please contact your dealer or the manufacturer's service department. In correspondence or during a telephone call regarding the purchased machine, please have the following data ready:

- Manufacturer number of the machine
- Voltage and frequency
- Year of manufacture of the machine
- Detailed description of the fault
- Detailed description of the type of machining
- Operating time of the machine in working hours
- For questions about the electrical system, the information on the name plate of the machine is also required.

6.2 Emission levels

6.2.1 Noise information

The values given are emission levels and therefore do not necessarily represent safe workplace values. Although there is a correlation between emission and immission levels, it cannot be reliably deduced whether additional precautionary measures are necessary or not.

Factors that may affect the current immission level at the workplace include the duration of exposure, the nature of the workspace, other noise sources, etc., e.g. the number of machines and other activities in the vicinity. The permissible workplace values can also vary from country to country.

However, this information should enable the user to make a better assessment of hazard and risk.

6.2.2 Noise emission values

The specified measured values were determined acc. to the machine-specific European standard **EN 1870-10**. The **DIN EN ISO 3746** standard was used to determine the sound power levels.

Sound power level UTK 600	
Idle:	98 dB(A)
Machining:	104 dB(A)

The **DIN EN ISO 11202** standard was used to determine the workplace-related emission values.

Workplace-related emission value UTK 600	
Idle:	83 dB(A)
Machining:	89 dB(A)

Remark:

For both the sound power levels and the workplace-related emission values, the supplement of **CEN TC 142** to the above-mentioned standards was used.

Uncertainty allowance $K = 4 \text{ dB(A)}$

	<i>As soon as the noise emission values of the machine partly exceed 85 dB(A), a suitable hearing protection must be provided to the personnel! This hearing protection must be worn by all employees in the noise area during sawing work.</i>
---	--

6.2.3 Dust emission values

If the machine is correctly connected to a sufficiently powerful extraction system (air speed min. 20 m/s in the total connection), it can be assumed that the 2.0 mg/m³ limit value for wood dust at the workplaces will be permanently complied with.

To ensure that the chips extracted at the point of origin and the dust are transported on to the collection system, the conveying speed of the extracted air must be 20 m/s for dry chips and 28 m/s for moist chips (moisture 18% or more).

	<i>The pressure drop at each extraction point should not exceed 1500 Pa. Otherwise, this could mean that the machine is not compatible with the extraction system.</i>
---	---

7 Dimensions

7.1 UTK 350

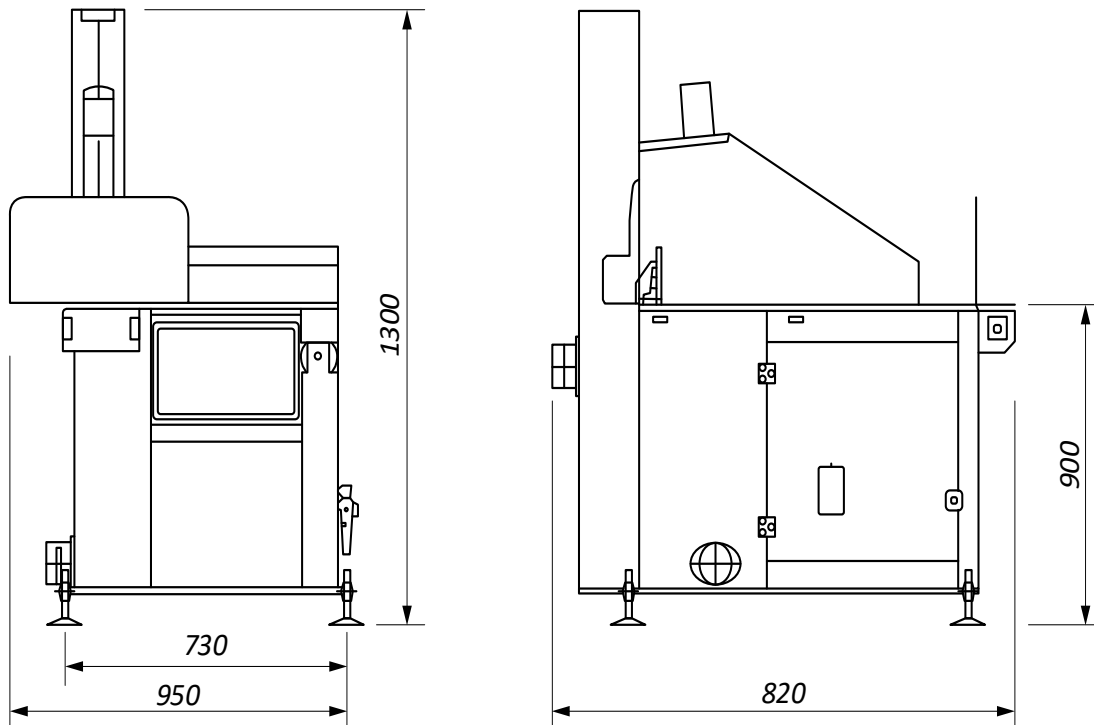

Figure 8: UTK 350 dimensions

Subject to design and dimensional changes!

7.2 UTK 450

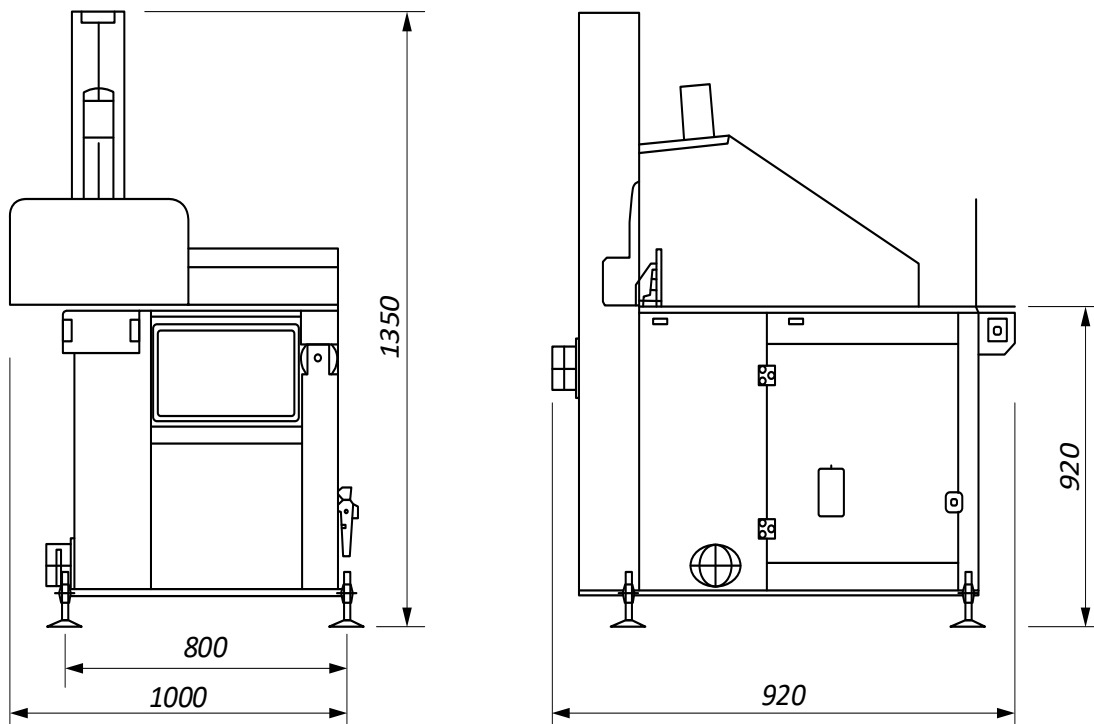
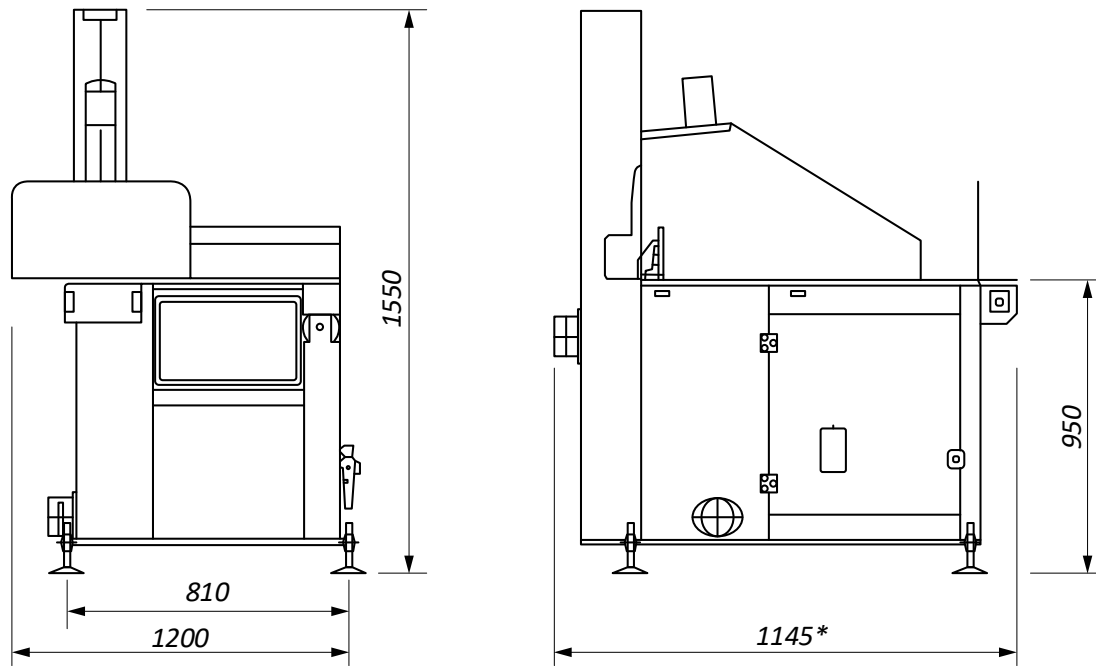

Figure 9: UTK 450 dimensions

Subject to design and dimensional changes!

7.3 UTK 500



*) 1335 mm with pneumatic protection shield (option)

Figure 10: UTK 500 dimensions

Subject to design and dimensional changes!

7.4 UTK 600

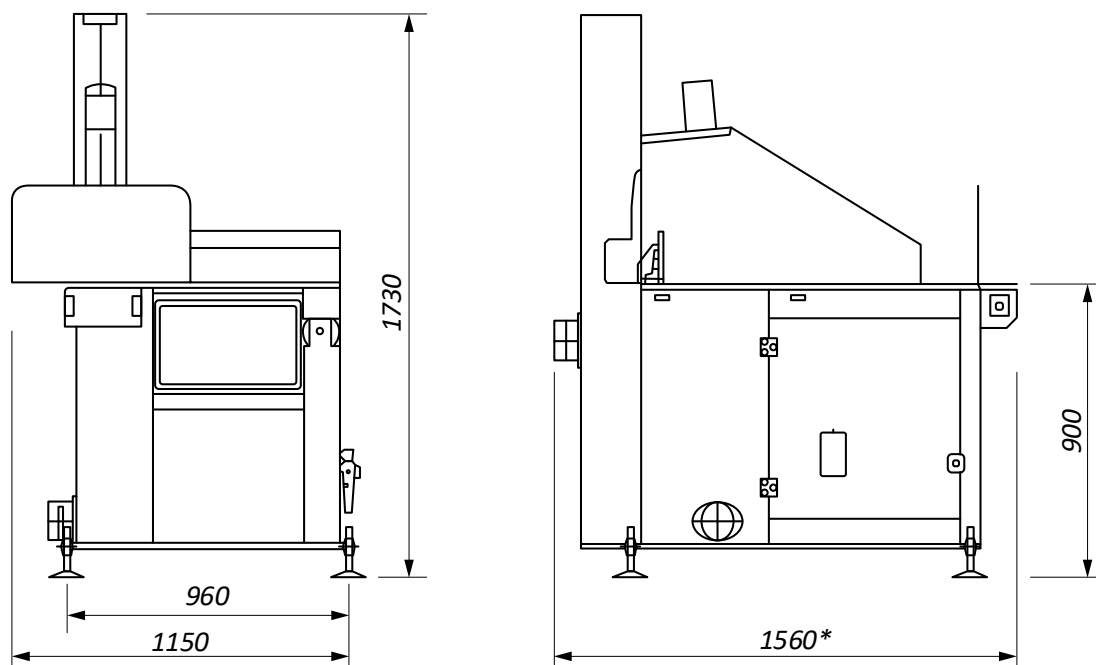

*) 1660 mm with pneumatic protection shield (option)

Figure 11: UTK 600 dimensions

Subject to design and dimensional changes!

8 Installation and connection

8.1 Check delivery conditions

Check the consignment for completeness and possible transport damage. In case of transport damage, please keep the packaging and inform the shipping company and the manufacturer immediately! Later complaints cannot be accepted.

8.2 Transport to the installation site

Transport the transport unit to the installation site of the under-table cross-cut saw. A specially made foundation is not required. The installation surface must have a load-bearing capacity corresponding to the weight of the machine. The machine weight can be found in the section ⇒ 6.1 “Technical specifications”.

	<p>The fork length of the forklift truck resp. pallet truck must be <u>at least 1.20 m!</u></p>
---	--

	<p>Danger to life when using a forklift truck! Keep a sufficient distance from the forklift truck and watch its speed. Vehicles with combustion engines also produce toxic exhaust gases. Wear a breathing mask if necessary.</p>
---	--



Figure 12: transport on pallet

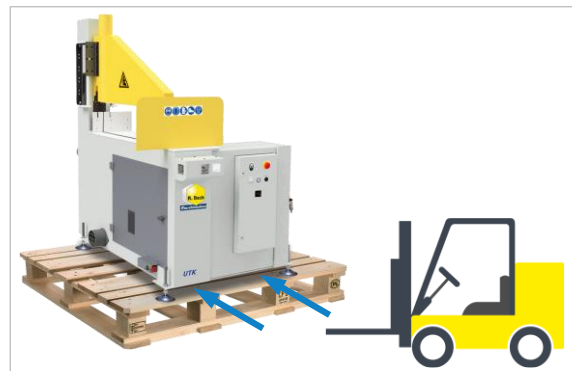



Figure 13: lifting off the pallet

- The under-table cross-cut saw is delivered standing upright on a transport pallet and is bolted to the floor of the transport pallet via the four feet. The centre of gravity of the machine is approximately in the middle of the pallet.
- Move a lift truck between the pallet timbers and lift the pallet only a few centimetres. Move the forks of the lift truck towards the pallet as shown in ⇒ Figure 12.
- Now move the machine to the immediate vicinity of the installation site.
- Dismantle all transport screw fastenings of the machine from the transport pallet.
- Then drive the forklift truck under the machine from the front (as shown in ⇒ Figure 13) and lift the machine only a few centimetres.
- Then carefully lift the machine off the pallet with the forklift and set it down.
- Then drive the machine underneath with a lift truck, lift it only a few centimetres and transport it to the final installation site. For further procedure refer to section ⇒ 8.3.

	<p>Ensure safe transport and pay attention to the existing risk of tipping due to the relatively high centre of gravity of the transport unit on the pallet!</p>
---	---

	<p>The load capacity of the forklift truck / lift truck must be designed for the weight of the machine.</p>
---	--

	<p>Be aware of possible <u>crushing hazards</u> when placing the machine (from the pallet to the floor) by means of a forklift truck. Pay particular attention to your hands and feet and wear <u>safety shoes</u> and <u>protective gloves</u> as a precaution.</p>
---	---

8.3 Machine installation

Ensure that there is sufficient space around the machine. To ensure that maintenance, repair, inspection and cleaning work can also be carried out without obstructions, a free space of at least 1.0 m must be allowed on all four sides of the machine (including roller conveyors) when setting up. The effective space requirement also depends on the length of the workpieces to be machined.

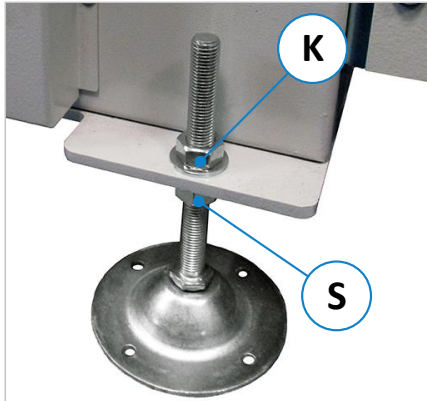





Figure 14: levelling via the feet

- A foundation is not required. For safe operation of the machine, the floor of the installation site must have a load-bearing capacity of at least 1000 kg/m².
- The bare parts of the machine are greased to protect them from corrosion. Carefully degrease the parts protected against rust with petroleum or benzene.
- After setting up, the machine must be levelled via the four feet and with the aid of a machine spirit level. To do this, loosen the lock nuts (**K**) and adjust the height via the adjusting nuts (**S**) shown in ⇒ Figure 14.
- The feet are provided with mounting holes that allow them to be fixed to the floor with heavy-duty dowels.

Remark: Additional tables or measuring resp. roller conveyors must be adjusted to the level of the machine table. Also align them correctly to the height of the machine table using a machine spirit level.

	<p><i>It is essential that the machine is level! Check with spirit level!</i></p>
	<p><i>Dispose of the packaging material in an environmentally friendly way!</i></p>
	<p><i>Do not use nitro thinner for cleaning. Painted surfaces of the machine can be damaged.</i></p>
	<p><i>Fire hazard! Do not smoke and do not light an open fire.</i></p>

8.4 Temporary storage

If the machine is not put into operation immediately after delivery, it must be stored carefully in a protected place. Carefully cover the entire machine so that neither dust nor moisture can penetrate.

The bare, non-surface-treated parts (e.g. the table top) are provided with a preservative. This must be checked regularly for effectiveness and renewed if necessary.

Ambient storage conditions: Temperature range: 5° C to +40° C | relative humidity: max. 90 %

8.5 Lashing in a transport vehicle

For later transport in a transport vehicle, the under-table cross-cut saw (as delivered) must be properly bolted to a pallet via the holes in the four feet and lashed to the floor of the loading area of the vehicle with at least two lashing straps. Loose and movable parts must be packed separately (e.g. in a cardboard box) and lashed to the pallet or on a separate pallet.



- ***A separate lashing strap must be used for each lashing and tensioned individually!***
- ***The machine must not be transported lying down!***
- ***The pallet must be additionally secured against slipping in the vehicle!***
- ***Secure the machine additionally with suitable aids against tipping over!***

The responsibility for safe loading is borne by the respective shipper!

Please note the following when lashing in the transport vehicle:

- The loading area of the transport vehicle must always be clean and dry.
- The lashing straps used must be suitable for the total weight of the machine (see section ⇨ 6.1).
- Fastening on the loading area is done by lashing down: This means that the transport pallet is secured by frictional locking. The load is pressed so firmly onto the loading surface that it can no longer slip. The clamping tool should have a high STF value at the frictional connection, e.g. long-lever ratchets.
- In addition, anti-slip mats should be used to provide even more safety.
- The ideal lashing angle (α) for tie-down lashing is 83° to 90°. Therefore, the lashing straps should pull downwards approx. vertically. As the angle decreases, the pretensioning force of the lashing is reduced.
- Observe the permissible total weight of the transport vehicle.
- Ensure that the permissible axle loads of the transport vehicle are observed. The load must be distributed evenly on all axles of the vehicle.

8.6 Workplace requirements

The effective space requirement depends on the external dimensions of the machine (see chapter ⇒ 6.2.3) and the dimensions of the workpieces to be processed. In general, provide sufficient space around the machine and also calculate the space required for setting work, the operating and auxiliary personnel as well as for the infeed and outfeed of long workpieces.

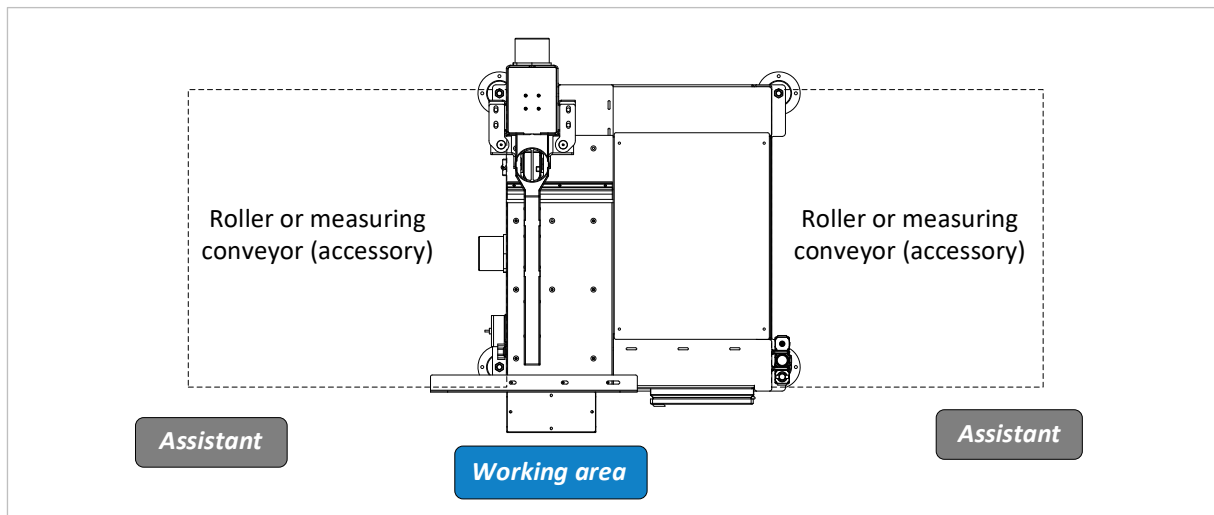



Figure 15: working positions

- Choose a suitable location for the machine and consider the working positions shown in ⇒ Figure 15.
- The machine must only be operated by a single person. The operator must stand on the position designated as “**Working area**” in ⇒ Figure 15 (directly in front of the Two-hand safety control).
- When using the machine in combination with additional roller resp. measuring conveyors, additional assistant personnel can be called in for the feeding and/or removal of workpieces if required. However, any assistant personnel must not be in the immediate vicinity of the machine but must stand at the corresponding table extension resp. roller resp. measuring conveyors for feeding and/or removal. These supplementary work positions are designated as “**Assistant**” in ⇒ Figure 15.
- Based on the external dimensions in chapter ⇒ 6.2.3, the possible workpiece dimensions and the calculated space for feeding and/or removing the workpieces, a free space of at least 1.0 m must be ensured around the machine, including additional tables and roller or measuring tracks.
- In addition, consider the existing hazardous areas (refer to section ⇒ 5.4).
- Sufficient lighting (min. 500 lux) must be ensured. The lighting must not dazzle and a stroboscopic effect must be avoided.
- Make sure that the floor can bear the load of the machine; the machine must be levelled via the four adjustable feet in the machine base using a machine spirit level.
- Additional tables as well as roller or measuring conveyors must be adjusted to the height of the machine table via the existing adjustable feet and also levelled with a machine spirit level.
- The chosen location must ensure connection to the electrical network, to the extraction system and to the compressed air supply.

8.7 Electrical connection

- | | |
|---|--|
|  | <i>The electrical connection must be carried out by an authorised electrician!</i> |
|  | <i>The fault loop impedance and the suitability of the overcurrent protection device must be checked at the installation site of the machine!</i> |

The electrical circuit diagrams are located in the control cabinet on the front of the machine.

Please observe the nominal voltage 400 VAC / 50 Hz (3 phases / N / PE)!



Figure 16: terminal box

- Ensure that the motor voltage (as indicated on the motor plate) matches the mains voltage.
- The supply cable (see section ⇒ 8.7.1) is inserted through the cable gland of the terminal box. The terminal box is located at the rear of the machine.
- The connection to the mains (3 phases) is made directly via the five screw terminals in the terminal box. The 3 phases are to be connected to the terminals “L1”, “L2”, and “L3”.
- The neutral conductor (blue) must be connected to the terminal marked “N” and the protective earth wire (yellow/green) to the terminal marked “PE”.
- Then close the cable gland again so that it is dust-tight.

	<i>Important: <u>Ensure correct direction of rotation of the saw shaft!</u></i>
---	--

The saw shaft must rotate according to the direction of the arrow shown in ⇒ Figure 17, so that the teeth of the circular saw blade rotate in the opposite direction to the operating side towards the rear of the machine.

If the running direction is incorrect, the connections of the phase lines “L1” and “L2” must be interchanged.

	<i>The regulations of the local energy supply company apply.</i>
---	---

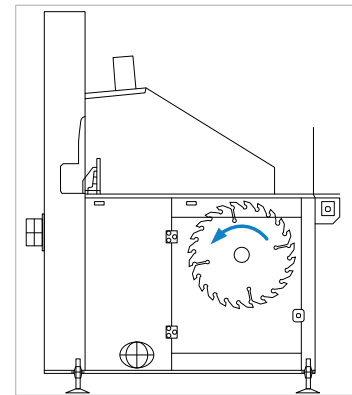

Figure 17: direction of rotation

8.7.1 Supply cable and back-up fuse

Cu, 5-core, the cross-section must be determined on site by a qualified electrician!

The electrical wiring and connection must be carried out by a specialist in accordance with the applicable regulations of the local power supply company as well as the VDE and EN regulations. We recommend the use of a rubber cable type H07RN-F, whereby additional measures must be taken to protect against mechanical damage.

Carry out the connection via on-site back-up fuses:

Motor 2.2 kW	Motor 3 kW	Motor 4 kW	Motor 5.5 kW	Motor 7.5 kW
16 A slow	16 A slow	16 A slow	20 A slow	25 A slow

For the power of your drive motor, please refer to the motor plate of the machine.

Please note: Only if the connection is carried out by an authorised electrician can a guarantee be given for the motor. In the event of a complaint, the electrician must confirm in writing that he has connected the machine in accordance with the regulations.

8.8 Connecting the extraction system

- The machine must be connected to an effective extraction system on site.
- Depending on the model, the machine has 2 or 3 suction nozzles. You will find the number and respective diameters of the suction nozzles for your machine model in the section ⇒ 6.1 “Technical specifications”
- All existing connections can be combined to form the total connection recommended in section ⇒ 6.1.
- If there is an upper suction nozzle on the guard, it must be connected with a flexible suction hose of sufficient length.

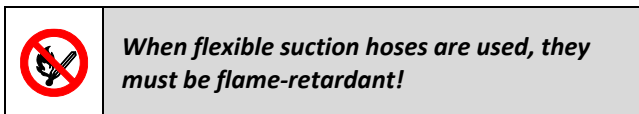

- For the suction nozzles on the machine body we recommend a connection via suction pipes.

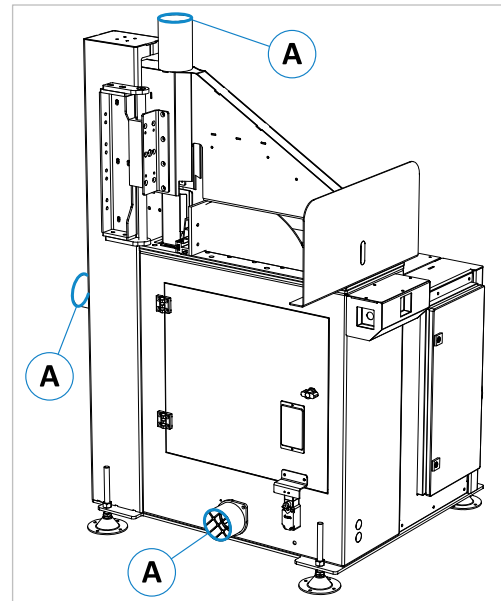

Figure 18: suction nozzles UTK 500 and 600



Figure 19: earthing example for suction hose

- Please ensure that the piping for the extraction connection is aerodynamic. This will ensure optimum conditions for the extraction system.
- All parts of the extraction system, including the hoses, must be included in the earthing measure (see earthing example in ⇒ Figure 19).
- After merging the extraction connections to the recommended total connection, a negative pressure of approx. 1200 Pa can be expected there at an air velocity of 20 m/s. This is an important parameter for the selection of the extraction system and its performance.

- For safe transport of the chips and dust collected by the extraction system, a minimum air speed to the total connection recommended in section ⇒ 6.1 is required. This is 20 m/s for dry chips and 28 m/s for moist chips (moisture 18 % or more).

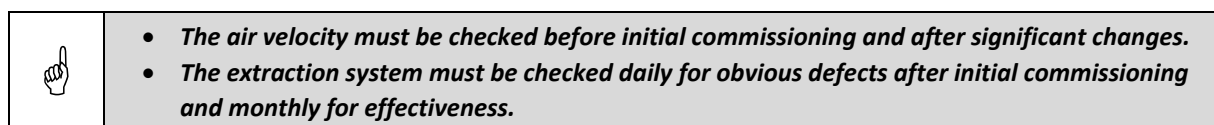

- If the machine is properly connected to a sufficiently powerful extraction system (min. air velocity 20 m/s in the total connection cross-section), it can be assumed that the wood dust assessment value of 2 mg/m³ is (permanently safely) complied with.

8.8.1 Automatic switching of the extraction system

The machine connector (S) is located in the immediate vicinity of the terminal box and can be used to connect the necessary signalling lines for automatic switching of the extraction system. Please refer to the electrical circuit diagram for the corresponding pin assignment for your machine model.

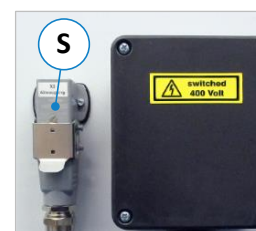
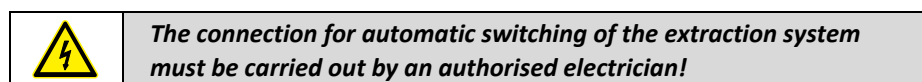

Figure 20: connector

8.9 Pneumatic connection

For the guard and the saw stroke to function as intended, the under-table cross-cut saw must be connected to a compressed air supply by a qualified person.

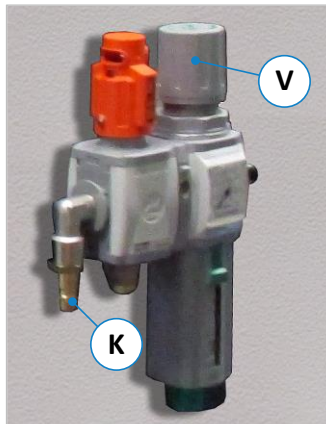

Figure 21: maintenance unit

Compressed air connection:

- The connection is made via the quick coupling (K) on the maintenance unit mounted on the machine body.
- After connecting the compressed air supply, the operating pressure can be set on the pressure regulating valve of the maintenance unit. Pull the rotary knob (V) of the pressure control valve upwards and set the correct operating pressure of 7 to 8 bar by turning it. This can be read on the pressure gauge directly below. Then secure the setting by pushing the rotary knob back down again.
- A label above the maintenance unit indicates the minimum operating pressure of 7 bar. The label also gives information about the required air volume per cycle (varies depending on the model).

Compressed air quality:

- The quality of the compressed air must comply with the standard ISO 8573-1:2010.
- In the case of central air treatment, water and oil particles must be separated via pre-filters and dryers downstream of the compressor.
- In the case of decentralised air treatment, a 40 µm filter must be used after the compressor.
- Before maintenance or repair work, the machine must be depressurised via the red actuating element on the maintenance unit. To do this, turn the red actuating element anti-clockwise ↺.

9 Components and controls



Figure 22: components and controls

Pos.	Description	Pos.	Description
1	Main switch (lockable)	9	Suction nozzles
2	Control cabinet with control switches	10	Workpiece fence
3	Air connection with maintenance unit	11	Adjusting knob for lifting speed
4	Emergency stop button	12	Door safety switch with interlock
5	Sawing table	13	Access door for saw blade change
6	Protective shield	14	Height adjustable feet (4 pieces)
7	Circular saw blade (accessory)	15	Two-hand safety switch
8	Pneumatic clamping guard		

10 Commissioning

Carefully read and observe the operating manual and the safety instructions ⇒ 5 before commissioning.

	<p>Before switching on, always ensure that</p> <ul style="list-style-type: none"> • the floor around the machine is clean and free of disturbing parts and workpieces, • no persons are in the danger zones of the machine, • no loose parts or tools are lying on the workpiece support surface, • the main switch is switched on and the signal lamp “ready for operation” is lit, • the compressed air supply is connected and an operating pressure of 7 - 8 bar is set, • the extraction system is connected and in working order, • the pneumatic guard is in the upper position (home position) and • the adjustment knob for the lifting speed is initially set all the way to the right.
---	--

10.1 Control switches and signal lamps

The control cabinet door on the front of the machine contains the following switches and signal lamps:

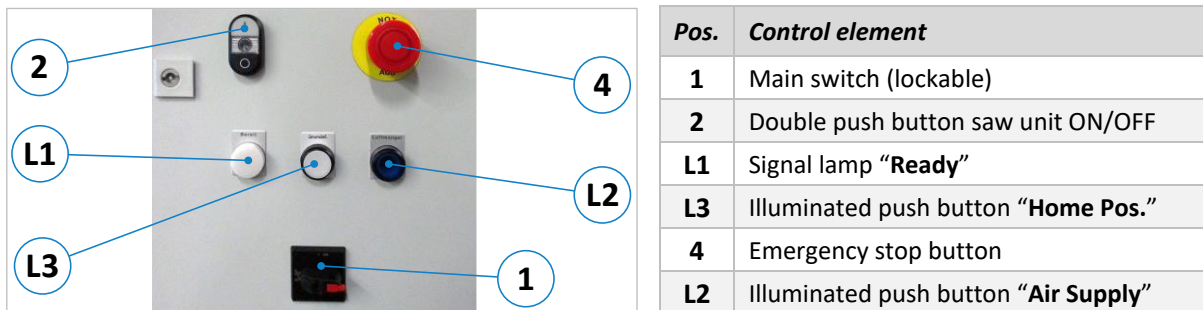

Figure 23: control panel with switches and signal lamps

Pos.	Detailed functional description
1	The main switch (1) is integrated in the front of the control cabinet door. By turning it, the control voltage of the under-table crosscut saw is switched on and off (position: left = OFF / top = ON). After switching on, the safety PLC needs approx. 10 s to run up. Only then is the control ready for operation. The main switch can be secured with a padlock against unauthorised switching on.
2	The double push button (2) is used to switch the circular saw unit on and off. If the “I” button is pressed on models with a motor power of 3 kW or more, the button flashes until the saw blade reaches full speed (star-delta start-up) and then lights up permanently. On 2.2 kW models it lights up permanently immediately. To switch off the circular saw unit, press the “O” button.
L1	The white signal light (L1) “Ready” lights up continuously when the machine is ready for operation (saw blade access door closed, emergency stop not activated and motor protection not triggered). If there is a fault, the signal light flashes in recurring flashing sequences triggered by the safety PLC. The meanings of the flashing sequences are described in detail in section ⇒ 12.3.
L3	With the illuminated push button (L3) “Home Pos.” the machine can be brought into the home position if required. Home position means that the machine is ready for workpiece feeding → The clamping guard is in the upper position, the circular saw blade is under the table, the pneumatically lowerable guard (option) is in the lower position resp. the pneumatic horizontal clamps (option) are open.
4	In case of emergency or danger, the circular saw blade drive can be stopped by pressing the emergency stop button (4) → The drive motor comes to a standstill within the prescribed braking time of < 10 s. If the emergency stop button is pressed by a second person during a cutting operation, the cutting stroke is also switched off in addition to the circular saw blade drive → The saw unit is lowered immediately under the machine table.
L2	The blue illuminated push button “Air Supply” (L2) lights up if the recommended operating pressure of 7 to 8 bar is too low or no compressed air is available → The saw blade drive switches off or cannot be started. As soon as the compressed air supply resp. the operating pressure is restored, the fault can be acknowledged by pressing the push button with warning light (L2) and the drive can be started again.

10.2 Frequent switching ON and OFF in succession

Avoid switching on and off several times in quick succession, as a bandsaw machine is not designed to be switched on and off constantly. This may cause an overload, which will trip the fuses or the motor protection device. In addition, on larger models with mechanical motor brakes and high flywheel mass, frequent switching on and off can cause damage to the motor brake. The mechanical motor brakes of the bandsaws are designed for a maximum of 10 braking cycles per hour.



Switching on and off several times in short intervals can cause damage to the machine and/or the motor brake.

10.3 Home position

After a cut has been made, the machine automatically returns to its home position, i.e. the machine is ready to support and feed a workpiece → The pneumatic clamping guard is in the uppermost position, the saw blade is lowered under the table, a pneumatically lowerable guard (option) is in the lower position and any pneumatic horizontal clamps (option) are open.

In case of malfunctions or interruptions in the work process (see also section ⇒ 11.8.3.1), the machine can be brought into the home position by command via the push button (L3) shown in ⇒ Figure 23.

10.4 Two-hand safety control



Figure 24: two-hand safety control

- The two-hand safety control consists of two actuating elements (buttons) which must be actuated simultaneously to trigger a cutting stroke. "Simultaneously" means that both buttons must be pressed within 0.5 s → A single cutting stroke follows without time delay.
- Before triggering a cutting stroke, the circular saw blade drive must be switched on via the double push button (2), see ⇒ Figure 23.

- If only one of the two buttons is released during the cutting process, this means that the cut command is immediately cancelled → The saw unit, clamping guard and optional pneumatic cylinders return automatically to their home position according to the behaviour in section ⇒ 11.8.3.1 or, if necessary, must be set manually to the home position via the push button "Home Pos."
- To trigger a new cutting stroke, the two-hand safety control must be actuated again..



These measures for triggering the cutting stroke are prescribed in the DIN EN 1870-10 standard for under-table crosscut saws and serve to ensure the safety of the user

10.5 Regulating the lifting speed

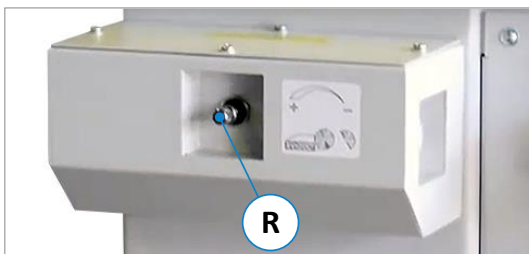

Figure 25: adjusting knob for lifting speed

With the adjusting knob (R) at the front of the two-hand safety control, the lifting speed of the saw blade can be infinitely adjusted via a throttle valve.

- ↺ Turn to the left → increase lifting speed
- ↻ Turn to the right → reduce lifting speed

Adjustment range: approx. 13 - 375 mm/s, whereby the rightmost position means 0 mm/s.



First turn the adjustment knob all the way to the right. Then start with a low lifting speed and gradually adjust it to the material to be processed. A lifting speed that is adjusted too high can cause damage to the circular saw blade and/or saw unit when working with hard wood! The lifting speed must generally be adapted to the material to be processed.

10.6 Door interlock with safety switch

To prevent unintentional opening of the door during operation and the associated dangers, the machine is equipped with a safety switch on the access door to the saw blade drive. This has the effect that before the access door is opened, any saw blade drive that may still be switched on is automatically braked and brought to a standstill.

 **The access door to the saw blade drive can only be opened if the safety switch has been unlocked beforehand with the knurled screws (R). In order to be able to restart the machine afterwards, the safety switch must first be brought into the locked state.**

 **The locking of the access door to the saw blade drive is prescribed in the DIN EN 1870-10 standard for under-table cross-cut saws and serves the safety of the user.**

Unlock: To open the door, the knurled screw (R) on the safety switch must be turned fully clockwise ↻ up to the stop so that the threaded pin (G) protrudes completely from the housing of the switch.

→ The door is unlocked and can be opened.

Lock: After closing the door, the safety switch must be locked again. To do this, turn the knurled screw (R) on the safety switch fully counter-clockwise ↺ until the grub screw (G) disappears completely into the knurled nut again.

→ Only then the machine can be started again.

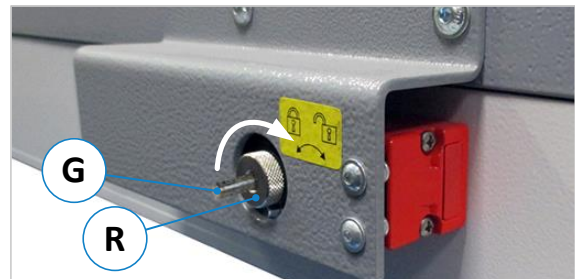

Figure 26: safety switch UTK 600 - door unlocked



Figure 27: safety switch UTK 600 - door locked



Figure 28: vertically mounted safety switch

Remark: Depending on the model, the position of the safety switch (vertical or horizontal) and the shape of the housing may differ from the two figures shown above. However, the procedure for locking and unlocking is identical for all variants. In addition, a sticker on the switch shows the correct direction of rotation of the knurled screw for unlocking and locking.

The ⇒ Figure 28 on the left shows the vertically mounted safety switches of the UTK 350, 450 and 500 models.

10.7 Installing a circular saw blade

To ensure safe working without incidents, the installation resp. change of a circular saw blade must be carried out properly. To install the circular saw blade, proceed as described below.

	<p>Caution: Cutting hazard! Only change saw blades when wearing protective gloves!</p>
---	---

- If necessary, switch off the circular saw unit using the double push button (2) shown in ⇒ Figure 23.
- In the home position (see section ⇒ 10.3) the saw unit with the circular saw shaft is below the machine table in the machine body.
- Before mounting the circular saw blade, make sure that it complies with the required technical specifications of your UTK model (see section ⇒ 6.1).
- To install the circular saw blade, unlock the safety switch according to section ⇒ 10.6 and open the access door (13) shown in ⇒ Figure 22 on the left side of the machine.
- **Then also switch off the main switch (1) and secure it with a padlock.**

	<p>Only circular saw blades that comply with the technical specifications may be installed.</p>
---	--

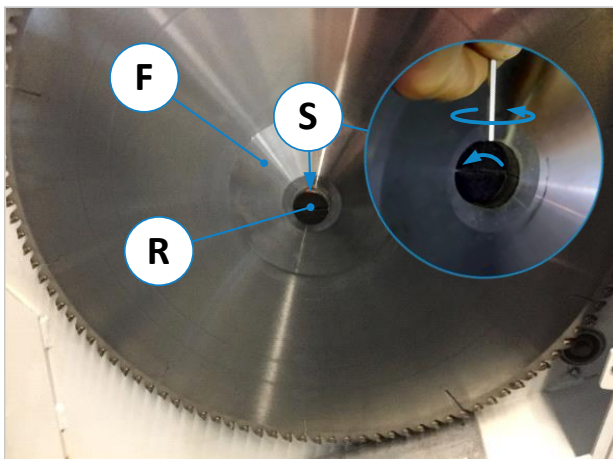



Figure 29: saw blade disassembly via expansion cone flange



Figure 30: direction of rotation of the saw blade

- ⇒ Figure 29: Loosen the grub screw (S) in the knurled screw (R) with the Allen key supplied. Then unscrew the knurled screw (R) and remove the flange (F) and, if necessary, the old circular saw blade.
- **Important:** The circular saw blade may only be fixed to the circular saw shaft via the “ProLock” expansion cone flange (see ⇒ Figure 30), because only the cone expansion causes a safe clamping of the saw blade.
- ⇒ Figure 30: If necessary, clean the saw blade shaft from any dirt and then place the new saw blade on the shaft so that the teeth point in the correct anti-clockwise direction of rotation ↺.

	<p>Only use this flange, otherwise it is not possible to securely fasten the circular saw blade!</p>
---	---

- To fix the new circular saw blade, put the flange (F) back on the saw shaft and tighten the knurled screw (R) by hand. The flange must now rest on the saw blade base body consistently and without play.
- Now tighten the grub screw (S) of the expansion cone clockwise ↻ again using the Allen key.
- To complete the saw blade installation, close the access door properly and lock the safety switch according to section ⇒ 10.6 to release the saw blade drive again.
- Then switch the main switch on again.
- The machine is now ready for operation.

11 Working with the under-table cross-cut saw

It is assumed that the under-table cross-cut saw is ready for operation with the circular saw blade mounted in accordance with the technical specifications for the respective UTK model (see section ⇒ 6.1). The mounted circular saw blade must also be suitable for the work to be carried out and the material to be processed.

11.1 Pneumatic clamping guard

The guard is used to cover the circular saw blade from above and at the same time to clamp the workpieces to be processed. It is positioned centrally above the cutting plane and is triggered pneumatically via the two-hand safety control (see section ⇒ 10.3). Also note the hazardous areas listed in section ⇒ 5.4.

Remark: The clamping guards of the UTK 500 and UTK 600 models are equipped with a suction nozzle on the upper side, whereas the UTK 350 and UTK 450 models are equipped with a suction nozzle on the lower right side of the guard on the machine column (see example figures below).

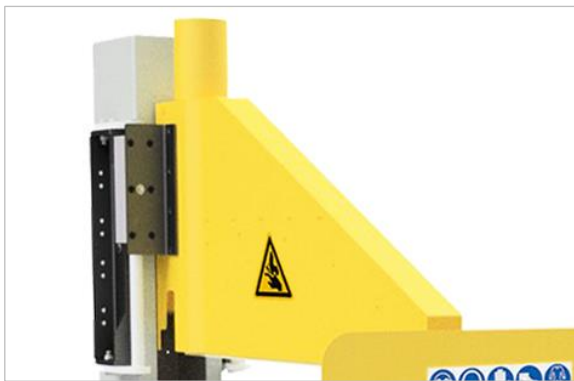

Figure 31: clamping guard for model UTK 600



Figure 32: clamping guard for model UTK 350

11.1.1 Function of the clamping guard

- As soon as the machine is correctly connected to the compressed air supply, the guard automatically moves upwards to its home position.
- In the home position, the guard releases the maximum possible machining cross-section of the workpieces above the machine table. The workpiece can be fed in this state and placed against the workpiece fence.
- When the cut is subsequently triggered via the two-hand safety control, the guard lowers to clamp the workpiece and covers the circular saw blade from the top.

11.2 Protective shield

 **Measures to secure access to the saw blade are prescribed in the DIN EN 1870-10 standard for under-table cross-cut saws and serve to ensure the safety of the user.**



Figure 33: protective shield (standard version)

- The fixed, rigid standard shield is mounted in front of the cutting plane and serves to secure access to the saw blade
- The protective shield prevents direct access to the saw blade from the front and thus serves as an important safety measure for the machine's operating personnel.



Removal of the protective shield and operation of the machine without the protective shield in place is prohibited!

11.3 Lowerable protective shield (pneumatic option)



 **Measures to secure access to the saw blade are prescribed in the DIN EN 1870-10 standard for under-table cross-cut saws and serve to ensure the safety of the user.**



Figure 34: optional pneumatic protective shield

For the UTK 500 and UTK 600 models, a pneumatically operated protective shield is available as an option. In the rest position, this protective shield is positioned below the machine table.

- When the two-hand safety control for the cutting stroke is actuated, the protective shield is first moved to the upper protective position.
- Only after the complete protective position (position all the way up) has been reached does the cutting stroke take place. This locking measure is designed in a safety relevant manner.

 **Operation of the machine without a functioning protective shield is prohibited!**

Important note: This option cannot be combined with the optional horizontal clamping device (see ⇒ Figure 38).

11.4 Full protection cover with viewing window (option)



 **Measures to secure access to the saw blade are prescribed in the DIN EN 1870-10 standard for under-table cross-cut saws and serve to ensure the safety of the user.**



Figure 35: full protection cover with viewing window

All UTK models can be equipped with an optional full protection cover, which is permanently mounted over the pneumatic clamping guard and covers the circular saw blade from above and from the front (for corresponding article numbers refer to chapter ⇒ 14).

- The integrated viewing window allows a direct view of the circular saw blade area even during a cut.

 **Removing the optional protective cover and operating the machine without the protective cover in place is prohibited!**

11.5 Workpiece fence

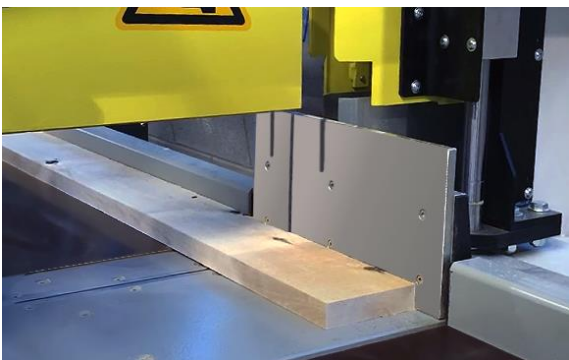

Figure 36: workpiece fence

The machine has a fence in the rear cutting area of the saw blade which fixes the workpiece parallel to the rear edge during a cut.

- Always ensure clean fence plate surfaces!
- To enable a workpiece to be cut to an exact right angle, it must always be placed directly against the workpiece fence before a cut is triggered (see ⇒ Figure 36 on the left).
- The fence plate is split in two so that the circular saw blade fits through the air gap during a cut.

Important note: When handling the workpiece fence, also observe the hazardous areas in section ⇒ 5.4.

11.5.1 Options in addition to the workpiece fence

Inclined machine design (option):

The machine design, which is inclined backwards by 10°, makes it easier and more convenient to push a workpiece lying on the machine table against the workpiece fence and place it there.



Figure 37: inclined machine design

Remark: The option "inclined machine design" is only available for the two models UTK 350 and UTK 450.

Important note: When handling the pneumatic horizontal clamping device, also observe the additional danger of crushing (see "Hazardous areas" in section ⇒ 5.4).

The article numbers for the above options can be found in the chapter ⇒ 14 "Options and accessories".

Horizontal clamping device (pneumatic option):

This presses the workpiece against the workpiece fence during the cutting stroke with two horizontal clamps. Thus, workpieces are not only clamped from above but also horizontally.



Figure 38: pneumatic horizontal clamping device

Remark: The pneumatic horizontal clamping device cannot be combined with the optional pneumatically actuated safety shield (see ⇒ 0).

11.6 Safe workpiece support



Risk of injury due to workpieces tipping and falling down if the workpiece support surface is insufficient!



Important note: According to CE regulations, an additional work table (optionally with or without castors) is required for the operation of the machine!



Figure 39: roller conveyor mounted on one side

- Always ensure that the workpiece is supported safely, especially with long and heavy workpieces.
- Regularly clean the support surfaces of the machine table and additional work tables and roller conveyors.
- The workpiece must rest securely on the machine table on both the feed side and the removal side.
- Even after a cut has been made, the workpieces must rest securely on the left and right of the cutting plane.
- Therefore, generally ensure that there is sufficient support to prevent the workpieces from dangerously tipping over and falling down.
- Additional work tables or roller and measuring conveyors on the infeed and outfeed side provide an effective remedy (see example in ⇒ Figure 39).

A wide range of manually or electronically controlled roller and measuring conveyors from Beck Maschinenbau GmbH can be found at <https://beck-maschinenbau.com/en/products/roller-measuring-conveyors/>.

11.7 Condition of the circular saw blade



Figure 40: saw blade access door

- Always check the condition of the circular saw blade before starting work. To do this, release the access door to the circular saw blade for opening by first unlocking the door safety switch (see section ⇒ 10.6).
- If the sharpness is no longer satisfactory or if there are signs of damage, replace the mounted circular saw blade with a new one resp. one that has been sharpened properly. The detailed procedure for this can be found in section ⇒ 10.7.



Caution: Cutting hazard! Only change saw blades when wearing protective gloves!

Ensure that the replaced circular saw blade that is no longer sufficiently sharp is resharpened. If the saw blade is damaged or defective, it must be disposed of properly according to the general disposal regulations (see also chapter ⇒ 15).

11.8 Sequence of workpiece machining

11.8.1 Adjust the lifting speed

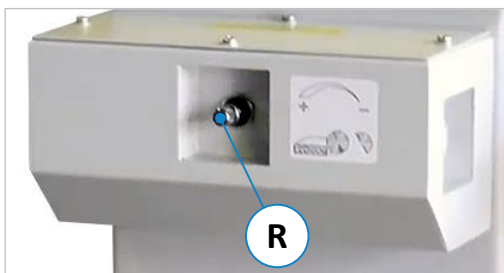

Figure 41: adjustment knob for lifting speed

- First switch on the circular saw unit using the double push button (2), see ⇒ Figure 23.
- To set a low lifting speed for the cutting stroke, first turn the adjustment knob (R) all the way to the right and then turn it again a little to the left.
- Always adjust the lifting speed to the material to be processed before triggering a cut.



Always start with a low lifting speed first and then gradually adjust it to the material to be processed. A lifting speed that is too high can damage the circular saw blade and/or saw unit on hard wood! The lifting speed must generally be adapted to the material to be processed.

11.8.2 Feeding and positioning the workpiece



Figure 42: manual positioning system with flip stop

- Place the workpiece on the machine table and position it to the desired cutting dimension.
Note: The positioning can be carried out either on the scribe mark or, for example, by a manually adjustable or automatic positioning system.
- Before starting a cut, make sure that the workpiece is correctly positioned against the workpiece fence.

Remark: A laser cutting line indicator is available as an option. With this, the kerf can be visualised directly on the workpiece. For more details on the option see section ⇒ 11.10.

11.8.3 Triggering the cutting stroke



Figure 43: cut triggering via two-hand control

Simultaneously press both buttons of the two-hand safety control and keep them pressed until the cut is completed and the saw blade has completely lowered under the table again.

Sequence when pressing both buttons (standard):

1. First, the clamping guard lowers onto the workpiece to clamp it from above.
2. The saw blade moves out and the cut is made.
3. Finally, the saw blade lowers again.
4. The clamping guard moves upwards again.

Sequence when pressing both buttons with lowerable protective shield (pneumatic option):

1. First, the protective shield moves all the way up to its full protective position.
2. Then the guard lowers onto the workpiece to clamp it from above.
3. The saw blade moves out and the cut is made.
4. Afterwards, the saw blade lowers again.
5. The clamping guard moves upwards again.
6. Finally, the pneumatic protective shield is retracted into the lower position.

Sequence when pressing both buttons with horizontal clamping device (pneumatic option):

1. First, the workpiece is clamped against the fence with the horizontal clamping device.
2. Then the guard lowers onto the workpiece to clamp it from above.
3. The saw blade moves out and the cut is made.
4. Afterwards, the saw blade lowers again.
5. The clamping guard moves upwards again.
6. Finally, the two pneumatic horizontal clamps open and release the workpiece.

- ➔ After a regular cut, the machine returns to its home position. If necessary, the workpiece can now be positioned for the next cut and the above processes can be repeated.
- ➔ When the machining of a workpiece is finished after one or more cut(s), remove the unmachined workpiece from the tables resp. roller conveyors of the infeed side and the already cut pieces from the removal side. Afterwards you can continue machining with the next workpiece.



Do not remove any workpiece sections or other workpiece parts from the cutting area as long as the saw blade drive is switched on and the circular saw blade protrudes from the table.



Make sure that the saw unit drive remains switched on during the cutting process.

11.8.3.1 Behaviour of the machine when a button of the two-hand safety control is released

Releasing both or one button(s) of the two-hand safety control - during the cutting stroke - will abort the operation and result in the following behaviours specified by the machine PLC:

Action	Standard	with Pneumatic option	Behaviour
Releasing a button during step	1. and 2.	1., 2. and 3.	<ul style="list-style-type: none"> • The machine automatically returns to its home position.
Releasing a button - <u>while the saw blade is retracting, but not yet completely lowered</u> - at step	3.	4.	<ul style="list-style-type: none"> • The saw blade continues to move in until it is completely below the table. • However, the clamping guard and the cylinders of the existing pneumatic option remain in position.
<p>➔ The machine must be returned manually to the home position by pressing the white push button (L3) "Home Pos." (see also section ⇨ 10.1 "Control switches and signal lamps").</p>			
Releasing a button during step	4.	5. and 6.	<ul style="list-style-type: none"> • The machine continues to run until all components are back in their home position.

11.9 Interruptions and end of work



- **Always switch off the circular saw blade drive even in the event of short interruptions.**
- **In case of longer interruptions or at the end of work, additionally switch off the main switch and secure it with a padlock against unauthorised restarting.**

11.10 Laser cutting line indicator (option)

As a workpiece positioning aid, the machine can be equipped with a laser cutting line indicator. The laser beam enables exact positioning of the circular saw blade on the workpiece scribe mark.

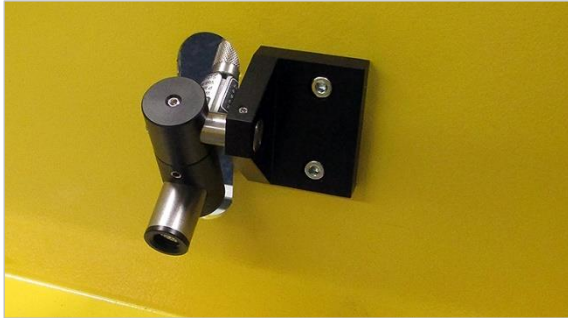

Figure 44: laser unit to indicate the cutting line

- The laser unit (see ⇨ Figure 44) is mounted behind the machine's protective shield. **Note:** With optional pneumatic clamping guard, the laser can also be mounted directly on the clamping guard (depending on the model).

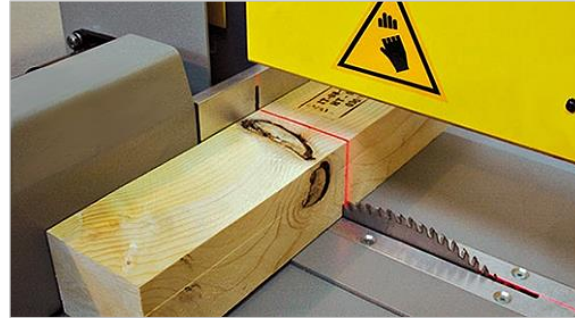

Figure 45: visualisation of the cutting line on the workpiece

- The laser beam points from the working area towards the circular saw blade.
- It is in exact alignment with the circular saw blade and visualises the kerf directly on the workpiece (see ⇨ Figure 45).

11.10.1 Particularities when using the laser cutting line indicator

For safe operation of the laser unit, the following points must be observed:

- Do not look into the laser beam.
- The laser is correctly positioned at the factory and must not be adjusted under any circumstances.
- The installed laser must not be replaced by a laser of a different type.
- No additional optical devices or attachments may be used.
- Laser repairs may only be carried out by the laser manufacturer or by authorised persons.
- Note that the laser beam may be reflected by reflective surfaces (e.g. the table top or other bare machine parts and/or accessories).



Warning: Looking directly into the laser beam will cause serious eye injuries!



The operating instructions of the laser manufacturer must also be observed.

Note: For the technical specifications and further information on the laser unit, please refer to the name plate of the delivered laser unit and the enclosed safety sticker.

12 Troubleshooting



- **Before any troubleshooting, switch off the main switch and secure it with a padlock.**
- **After each troubleshooting, all guards and safety devices must be put back into operation and checked for functionality!**

- Only carry out troubleshooting work if you are familiar with the operation of the machine and if you are authorised and have received safety training.
- Work on the electrical equipment of the machine may only be carried out by a qualified electrician.
- Work on the pneumatic equipment may only be carried out by trained specialists.
- Before carrying out troubleshooting work, switch off the machine and, if necessary, secure it against unauthorised restarting.
- Depressurise the machine by disconnecting the quick coupling to the compressed air supply.
- Keep the working area tidy and clean even during troubleshooting work.
- If protective devices have been removed during the troubleshooting work, it is essential that they are re-installed and checked for proper function after the troubleshooting work has been completed.
- Proceed systematically when searching for the cause of a malfunction.

If you are unable to find the fault or to remedy the malfunction, contact our customer service department (phone number: 0049 - 7576 / 962 978 - 0). Before you call us, please follow these steps:

- Make a note of the type, machine number and year of production (see nameplate).
- Keep this operating manual (and any circuit diagrams) to hand.
- Describe the fault to us in detail so that a competent remedy can be found.

12.1 Behaviour in the case of a power failure

If an unexpected power failure occurs during a machining operation resp. cutting stroke, the circular saw blade is automatically lowered under the table.

- Wait for the circular saw blade to come to a complete standstill before taking further action
→ Braking time of the motor brake: < 10 s.
- Clarify the causes of the power failure and if possible, restore the power supply.
- Once the power supply is restored, you can resume your work by starting the circular saw blade drive.



The braking effect of the saw blade drive is maintained even in the event of a power failure.

12.2 General faults

Fault	Possible cause	Remedy
The under-table cross-cut saw resp. the saw unit does not start	No voltage	→ Check connections (electrician!)
	Backup fuse defective	→ Replace fuse (electrician!)
	Main switch is turned off	→ Turn the main switch on
	Main switch defective	→ Replace switch (electrician!)
	Push button for drive defective	→ Replace push button (electrician!)
	Motor defective	→ Replace motor
	Drive belt broken	→ Replace all drive belts (⇒ 13.5)
	Access door to saw blade is open	→ Close door (⇒ 10.6)
	Door safety switch not locked	→ Lock safety switch (⇒ 10.6)
	Emergency stop button is pressed	→ Unlock button
	No compressed air supply or the operating pressure does not correspond to 7-8 bar	→ Wait for cooling time / contact customer service if necessary
Signal lamp (L1) "Ready" is not lit	→ Close the saw blade access door → Unlock emergency stop button → Check the motor protection switch in the control cabinet	
Motor gets very hot	Overload or defective motor	→ Restore compressed air and acknowledge with blue button
Saw drive squeaks when starting up	Drive belts are too loose	→ Retension drive belts (⇒ 13.4)
	Drive belts are worn	→ Replace all drive belts (⇒ 13.5)
Motor brake no longer brakes within 10 seconds	Brake pads are worn	→ Readjust motor brake (⇒ 13.6)
	Motor brake defective	→ Contact customer service
Machine vibrates strongly	Machine is uneven	→ Levelling the machine (⇒ 8.3)
Saw blade is strongly braked during machining	Drive belts slip	→ Retension drive belts (⇒ 13.4)
Saw blade is braked heavily during machining, guard does not clamp, horizontal clamping device (option) does not clamp or lowerable guard (option) does not raise	No compressed air supply and the blue illuminated push button (L2) is on	→ Restore compressed air (7-8 bar) and acknowledge with push button (L2)
	The operating pressure is too low and the blue illuminated push button (L2) is on	→ Restore compressed air (7-8 bar) and acknowledge with push button (L2)
Two-hand safety control does not work	Safety circuit defective	→ Contact customer service
	Motor is still starting up, the double push button (2) flashes	→ Wait until double push button (2) lights up statically (full speed reached)
	The illuminated push-button (L3) "Home Pos." is off	→ Move to home position by pressing push-button (L3)
Inaccurate cutting line	Saw blade blunt resp. worn out	→ Replace circular saw blade (⇒ 10.7)
	Lifting speed too high	→ Reduce lifting speed (⇒ 11.8.1)

12.3 Fault messages of the safety PLC

Other operating states are monitored by the safety PLC and signalled via the signal lamp (L1).

12.3.1 Monitoring the end positions and valves

Faults and errors are signalled by repeated flashing sequences of the signal lamp (L1) installed in the control panel of the machine (see also ⇒ Figure 23) and additionally indicated by flashing numbers on the PLC -K1.

Flash sequence L1	Description of the fault	Effect	Remedy ²
2 x repeatedly (PLC -K1 no. 32 flashes)	If the saw jams during retraction after sawing and does not reach the lower end position within 7 seconds, the motor is switched off. The saw cylinder continues to try to retract and the other cylinders remain in position.	Saw does not reach the lower end position after sawing	Check limit switches -1S1 resp. loosen jamming of the saw
3 x repeatedly (PLC -K1 no. 33 flashes)	If both limit switches (-1S1) "saw lowered" and (-1S2) "saw raised" are actuated at the same time, e.g. because the lower limit switch is stuck, the motor is again switched off, the saw cylinder retracts and the other cylinders remain in position.	Both limit switches of the saw are active at the same time	Check limit switches -1S1 and -1S2
4 x repeatedly (PLC -K1 no. 34 flashes)	If one of the two the push buttons (-2S1) "guard closed" or optionally (-4S1) "horizontal clamping device" opens during the sawing process, it is possible that the workpiece is no longer securely clamped. This error also leads to the motor being switched off. The sawing cylinder retracts. The other cylinders remain in position.	Pressure switch "guard closed" opens during the sawing process	Check limit switch -2S1 and valve -2V1
5 x repeatedly (PLC -K1 no. 35 flashes)		Pressure switch for the horizontal clamps opens during the sawing process	Check limit switch -4S1 and valve -4V1
6 x repeatedly (PLC -K1 no. 36 flashes)	The switch (-1S1) "saw lowered" may only open when the valve coil (-1M1) "raise saw" is activated. If it opens at any other time because it is defective or the valve has a defect, this is detected.	Limit switch "saw lowered" opens at the wrong time	Check limit switch -1S1 and valve -1V1
	Further error numbers of the PLC -K1 are listed in the circuit diagram, including remedial suggestions.		

12.3.1.1 Acknowledge faults after elimination

As long as an error is present, the drive cannot be started. A pending error can be cleared by pressing "O" on the double push button (2) or by switching the main switch (1) off and on.

12.3.2 Illuminated push button (L2) for operating pressure

As soon as there is a fault in the compressed air supply, the blue illuminated push button (L2) shown in ⇒ Figure 23 lights up continuously. The saw drive cannot be started until the fault has been acknowledged.

State of L2	Description of the fault	Remedy and acknowledgement
Lights up blue	The machine permanently monitors the pneumatic pressure. If the operating pressure drops below 7-8 bar, the saw motor stops, the saw retracts and the other cylinders remain in position.	→ Restore compressed air respectively operating pressure (7-8 bar) and then acknowledge the error with the blue illuminated push button (L2)

² The corresponding limit switches (S) and valve coils (M) can be found in the circuit diagram.

13 Maintenance and inspection

 **Before any maintenance and inspection work is carried out, chapter ⇒ 5 “Safety” must be read carefully and observed!**

 **Before maintenance and repair work, switch off the main switch and lock it with a padlock!**

Operational malfunctions caused by insufficient or improper maintenance can result in very high repair costs and long machine downtimes. Regular maintenance is therefore essential.

- Regularly check that your under-table cross-cut saw is in perfect condition.
- Clean the machine daily and the supporting surfaces of the machine table, table extensions and/or the roller conveyors always after finishing work. Cleaning the machine with compressed air is prohibited!
- Maintenance work on electrical and pneumatic equipment only by qualified personnel!
- Inspect electrical equipment/components weekly for externally visible damage and have them repaired by a qualified electrician if necessary.
- Immediately remove and replace damaged protective devices. Never work with damaged parts!
- If protective devices have been removed during maintenance work, it is essential to remount them immediately afterwards and check that they are functioning properly.
- The extraction system must be checked for obvious defects before initial commissioning and daily, and its effectiveness must be checked monthly.
- The air velocity to the extraction system must be checked before the initial commissioning and after significant modifications.
- Do not use the machine until these conditions are met.

Due to the different operating conditions, it is not possible to determine in advance how often a wear check, inspection or maintenance is required. Inspection intervals are to be determined appropriately according to the respective operating conditions.

13.1 Lubrication of the machine

The machine itself does not require lubrication. All ball bearings are maintenance-free. It is only necessary to check all sliding and rolling parts weekly for ease of movement and, if necessary, lubricate them with a thin-bodied oil.

13.2 General maintenance intervals

Interval	Component(s)	Measure
Before start of work	Circular saw blade	Check for sharpness, cracks and damage and sharpen resp. replace the circular saw blade if necessary.
	Compressed air supply	Correct pressure if necessary, check/drain maintenance unit.
	Extraction system	Check for function, defects and leaks.
After end of work	Machine, clamping elements, workpiece fence and table support surfaces, table extensions	Remove wood residues and chips. Clean the workpiece fence and table support surfaces as well as the clamping surfaces of the clamping guard and, if fitted, the optional horizontal clamp.
Weekly	Emergency stop button	Check the function of the emergency stop button.
	Door safety switch	Check the function of the door safety switch.
	Drive belts	Check for tension / wear and retension / replace if necessary.
Monthly	Motor brake	Check braking time until bandsaw blade standstill (< 10 s). If necessary, readjust the motor brake (see section ⇒ 13.6).

13.3 Check wear rail for circular saw blade

The table insert resp. wear rail reduces the table opening to the circular saw blade to a minimum and ensures a stable guidance of the saw blade with its narrow slot. Therefore, check the wear rail regularly for mechanical damage and cracks. In addition, the slot for the saw blade should always be as narrow as possible so that neither dirt nor chips can penetrate.

	<i>If the gap between the saw blade and the groove of the wear rail is too large, or if there are mechanical defects or damage, the rail must be replaced immediately!</i>
---	---

Order a new matching wear rail for your UTK model if required:

<i>Model</i>	<i>W x T x L</i>	<i>Art. No.</i>	<i>Model</i>	<i>W x T x L</i>	<i>Art. No.</i>
UTK 350	50 x 12 x 294,5 mm	80 006 018 02	UTK 500	50 x 12 x 442 mm	80 004 018 02
UTK 450	50 x 12 x 394,5 mm	80 005 018 02	UTK 600	50 x 12 x 885 mm	80 002 018 02

Only use original wear rails from the machine manufacturer (material: AlMgSi1).

13.3.1 Fitting and sawing in the replacement wear rail

	<i>The following procedure may only be carried out by qualified personnel!</i>
---	---

The wear rail ordered as a spare part, in the form of an aluminium T-profile, is already supplied in the appropriate length and including the necessary threaded holes for mounting in the table top of the machine.



Figure 46: wear rail in the state of delivery (example UTK 600)

- Insert the supplied replacement wear rail - with the centre bar facing upwards - from below into the saw blade recess of the machine table so that the mounting holes are correctly aligned.
- Fasten the rail from above with the countersunk screws provided (tighten well).



Figure 47: wear rail in the fitted state, still without slot (example UTK 600)

	<i>Important: After assembly, the <u>slot for the circular saw blade</u> must still be sawn in!</i>
---	--

Please proceed as follows for this one-time required procedure:

- Preferably use an aluminium circular saw blade and some cooling lubricant for sawing. The blade must have the same width as the wood circular saw blade used later on the machine.
- If no aluminium saw blade is available, we recommend using an older - but undamaged - wood saw blade of identical thickness (that is no longer in use) for this operation. Apply some cooling lubricant to all cutting teeth before closing the access door again.
- Before cutting, turn the lifting speed adjustment knob (see ⇨ 10.5) all the way to the right.
- Then make an empty cut (without workpiece) at the slowest lifting speed to saw a clean slot in the desired saw blade width into the wear rail.
- Then deburr the sawn slot on both sides from above and below with a suitable file.
- The wear rail is now ready for use (see ⇨ Figure 48).



Figure 48: ready-to-use wear rail with sawn slot (example UTK 600)

	<ul style="list-style-type: none"> • <i>If a wider saw blade is installed at a later stage, the slot can be enlarged to the higher width according to the procedure described above.</i> • <i>If a narrower saw blade is installed at a later date, a new wear rail must be used and a new slot sawn to match the saw blade thickness.</i>
---	--

13.4 Tensioning the drive belts



Before tensioning the drive belts, switch off the main switch and lock it with a padlock!



The drive belts may only be tensioned by qualified personnel!

The principle of V-belt tensioning is identical for all four UTK models: the motor mounting is loosened to create the correct belt tension via tensioning nuts. However, the number of tensioning nuts and the method of fastening the motor varies from model to model (refer to sections ⇒ / ⇒ 13.4.3 / ⇒ 13.4.4 / ⇒ 13.4.5).

➔ After the main switch has been turned off and locked, the motor cover plate on the right side of the machine must be removed to gain access to the motor and drive belt tensioning nuts (see example UTK 500 in ⇒ Figure 49).



Figure 49: motor cover plate removed

13.4.1 Adjusting the correct V-belt tension

Tension the belts only so tightly that they can still be pushed in a maximum of 1 cm by pressing them firmly with your thumb. **Recommendation:** You can achieve the optimum V-belt tension with a special belt tension gauge.

13.4.2 Retensioning the V-belt on model UTK 350

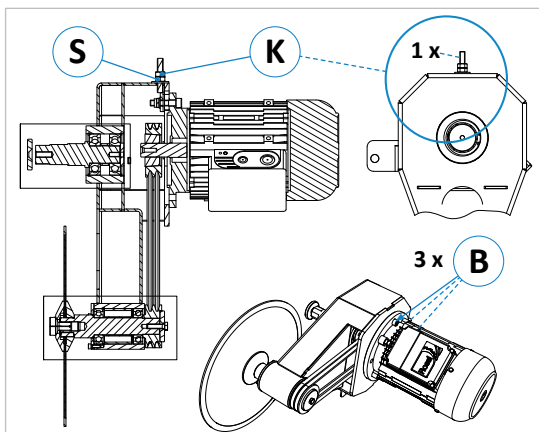

Figure 50: V-belt tensioning nuts UTK 350

- The motor of model UTK 350 is mounted with the 3 fastening screws (**B**) via the motor flange.
- For V-belt tensioning, first loosen the 3 fastening screws (**B**) of the motor slightly so that the motor can be moved during tensioning.
- The belt tension according to ⇒ 13.4.1 is achieved via the tensioning nut (**S**) right behind the motor.
- Loosen the lock nut (**K**) and retension the two belts with the nut (**S**).
- Then retighten the lock nut (**K**) and the 3 motor fastening screws (**B**).

13.4.3 Retensioning the V-belt on model UTK 450

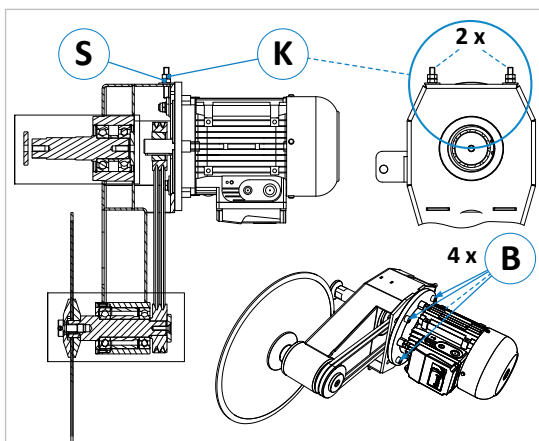

Figure 51: V-belt tensioning nuts UTK 450

- The motor of the model UTK 450 is mounted with the 4 fastening screws (**B**) via the motor flange.
- For V-belt tensioning, first loosen the 4 fastening screws (**B**) of the motor slightly so that the motor can be moved during tensioning.
- The belt tension according to ⇒ 13.4.1 is achieved via the 2 tensioning nuts (**S**) right behind the motor.
- Loosen both lock nuts (**K**) and retension the two belts with the two nuts (**S**).
- Then retighten the lock nuts (**K**) and the 4 motor fastening screws (**B**).

Important note: The two tensioning nuts (**S**) must be tightened consistently (e.g. alternately ½ turn each) to maintain the correct position of the motor.

13.4.4 Retensioning the V-belt on model UTK 500

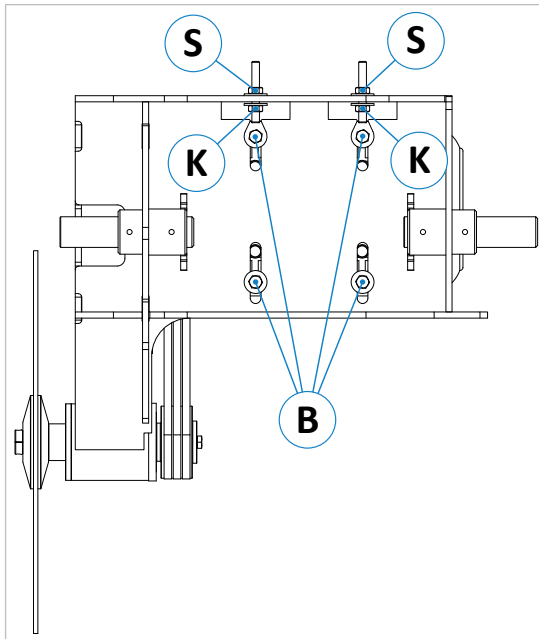

Figure 52: V-belt tensioning nuts UTK 500

- The motor of the UTK 500 model is fixed to a mounting plate with the 4 fastening screws (**B**).
- To tension the belts, the motor 4 fastening screws (**B**) must be loosened slightly so that the motor can be moved in the slotted holes of the mounting plate.
- The V-belt tension according to section ⇨ 13.4.1 is achieved via the 2 tensioning nuts (**S**) and lock nuts (**K**), which are arranged parallel to the longitudinal side of the motor.
- Loosen the lock nuts (**K**) and retension the belts with the two outer nuts (**S**).
- Then tighten the two lock nuts (**M**) and 4 fastening screws (**B**) again.

Important note: When tensioning via the nuts (**S**), make sure that the parallelism of the motor shaft to the saw shaft and the perpendicular belt position are maintained. If the alignment is skewed, the belts may later slip off the pulleys and wear will be increased.

Ensure parallelism by measuring if necessary.

 **Make sure that the motor shaft remains perpendicular to the belt position when tensioning the belts.**

13.4.5 Retensioning the V-belt on model UTK 600

- The motor of the UTK 600 model is fixed to a mounting plate with the 4 fastening screws (**B**).

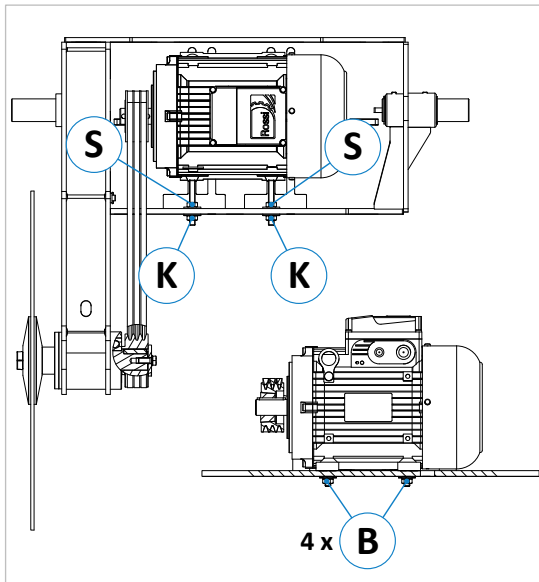

Figure 53: V-belt tensioning nuts UTK 600

- To tension the belts, the motor 4 fastening screws (**B**) must be loosened slightly so that the motor can be moved in the slotted holes of the mounting plate.
- The V-belt tension according to section ⇨ 13.4.1 is achieved via the 2 tensioning nuts (**S**) and lock nuts (**K**), which are arranged parallel to the longitudinal side of the motor.
- Loosen the lock nuts (**K**) and retension the belts with the two inner nuts (**S**).
- Then tighten the two lock nuts (**M**) and 4 fastening screws (**B**) again.

Important note: When tensioning via the nuts (**S**), make sure that the parallelism of the motor shaft to the saw shaft and the perpendicular belt position are maintained. If the alignment is skewed, the belts may later slip off the pulleys and wear will be increased.

Ensure parallelism by measuring if necessary.

 **Make sure that the motor shaft remains perpendicular to the belt position when tensioning the belts.**

13.5 Replacing the drive belts

It is not only in the case of a broken belt that the drive belts of the machine must be replaced. The same applies if the saw shaft starts to squeal when starting up and retensioning is no longer successful. Both cases indicate high wear, which is why all belts must always be replaced at the same time.



Before changing the drive belts, switch off the main switch and lock it with a padlock!

Please refer to the following table for the number and type designations of the belts for your UTK model:

<i>Model</i>	<i>V-belt type</i>	<i>Qty.</i>	<i>Model</i>	<i>V-belt type</i>	<i>Qty.</i>
UTK 350	Optibelt XPZ 862	2	UTK 500	Optibelt XPZ 900	3
UTK 450	Optibelt XPZ 987	2	UTK 600	Optibelt XPZ 1337	3



Important: All existing drive belts must always be replaced at the same time!

- The tensioning nuts (**S**) must first be loosened enough so that the old belts can be removed from the pulleys without jamming.
- As new belts are less extended than used ones, the tensioning nuts (**S**) must be loosened even further:
 - Loosen them until the new belts can be put on comfortably and without jamming.
 - Forcible fitting using a screwdriver or similar will damage the V-belts!
- After fitting the new belts, establish the correct V-belt tension by tightening the tensioning nuts (**S**). The procedure for this is described in the previous section ⇒ 13.4.
- After the first hours of operation, the belts should be retensioned for the first time. This will absorb the initial elongation.
- The types of V-belts listed in the table above only need to be tensioned occasionally after the run-in period, as they have very little elongation and therefore require little maintenance. If other makes are used, it may be necessary to continue monitoring the V-belt tension while the machine is running and to correct it again if necessary.

If you have any questions or problems when fitting or tensioning the new drive belts, please feel free to contact our customer service by calling 0049 - 7576 / 962 978 - 0.

13.6 Readjust motor brake

Check the brake function of the main motor monthly → If the machine no longer comes to a standstill within 10 seconds when braking, the motor brake must be readjusted.



The motor brake may only be readjusted by qualified personnel!

The procedure for readjustment varies depending on the motor power of the installed drive motor.

→ For the motor power of your under-table cross-cut saw, please refer to the motor's name plate.



Before readjusting the motor brake, switch off the main switch and lock it with a padlock!

Motor power 2.2 kW, 3 kW, and 4 kW:



Figure 54: brake adjustment screw 2.2 / 3.0 / 4.0 kW

- Insert an Allen key SW 5 through the fan cover into the hexagon socket of the front adjustment screw.
- Readjust the adjustment screw by a **maximum of 1/8** turn clockwise ↻.

Motor power 5.5 kW and 7.5 kW:



Figure 55: brake adjustment screw 5.5 / 7.5 kW

- Place a socket spanner SW 17 through the fan cover onto the hexagon of the front adjustment screw.
- Readjust the adjustment screw by a **maximum of 1/8** turn clockwise ↻.



Important: If the motor brake is adjusted too much, the brake will drag when the drive is started and may be damaged or even destroyed! Too much adjustment is present if a strong odour is noticed when starting the drive. In this case, switch off the machine immediately and reduce the adjustment slightly.

- Then switch the main switch on again and recheck the braking time of the machine.
- If the braking time is still above 10 s, repeat the setting procedure described above and check the braking time again.
- Be sure to avoid too much readjustment at once (see ⇒ information box above) and always proceed step by step → Readjust 1/8 turn → Check braking time...
→ If necessary, correct again by 1/8 of a turn → Check braking time again etc.
- If the readjustment does not lead to success, see section ⇒ 13.6.1.



If rattling noises occur in the area of the fan blade when turning the motor, please inform the customer service. It is possible that the brake lining is worn out.

13.6.1 Replacing the motor brake

If the adjustment of the motor brake described above does not lead to the desired success, the motor brake must be replaced. First make a note of the name plate and other information on your motor. Then contact our customer service (0049 - 7576 / 962 978 - 0) to order a suitable new brake.

14 Options and accessories

	<i>Only use original circular saw blades, accessories and spare parts specified by the manufacturer. The use of other accessories or spare parts can cause injury to persons and damage to the machine. The manufacturer accepts no liability for any damage resulting from the use of non-prescribed accessories and spare parts or additional components from third parties!</i>
---	--

14.1 UTK 350

14.1.1 Circular saw blades

Article	Description	Art. No.
HM circular saw blade for wood	350 x 3.5 x 2.4 x 30 Z72 WZ	UTK 19.02-H
HM saw blade for aluminium	350 x 3.5 x 3.0 x 30 Z90	UTK 19.02-ALU

14.1.1 Options and accessories

Article	Description	Art. No.
Boosted motor	4.0 kW (5.5 HP)	UTK 19.03
10° inclined machine table	adjustable	UTK 19.04
Full protection cover	mounted above the saw table	UTK 19.05
Laser cutting line indicator	laser beam with approx. 300 mm line length	UTK 19.06
Spraying device	Micro Cooler - for cutting aluminium	UTK 19.07
Horizontal clamping device	2 pieces front horizontal pneumatic clamps	UTK 19.08

Feed and stop roller conveyors with various measuring and stop systems for safe material support and perfect cuts can be found on <https://beck-maschinenbau.com/en/products/roller-measuring-conveyors/>.

14.2 UTK 450

14.2.1 Circular saw blades

Article	Description	Art. No.
HM circular saw blade for wood	450 x 4.8 x 3.0 x 30 Z84 WZ	UTK 16.02-H
HM saw blade for aluminium	450 x 4.4 x 3.8 x 30 Z102	UTK 16.02-ALU

14.2.1 Options and accessories

Article	Description	Art. No.
10° inclined machine table	adjustable	UTK 16.03
Full protection cover	mounted above the saw table	UTK 16.04
Laser cutting line indicator	laser beam with approx. 300 mm line length	UTK 16.05
Spraying device	Micro Cooler - for cutting aluminium	UTK 16.06
Horizontal clamping device	2 pieces front horizontal pneumatic clamps	UTK 16.07

Feed and stop roller conveyors with various measuring and stop systems for safe material support and perfect cuts can be found on <https://beck-maschinenbau.com/en/products/roller-measuring-conveyors/>.

14.3 UTK 500

14.3.1 Circular saw blades

Article	Description	Art. No.
HM circular saw blade for wood	500 x 5.6 x 3.6 x 30 Z84 WZ	UTK 18.02-H
HM saw blade for aluminium	500 x 4.0 x 3.4 x 30 Z120	UTK 18.02-ALU

14.3.1 Options and accessories

Article	Description	Art. No.
Boosted motor	7.5 kW (10 HP)	UTK 18.03
Pneumatic protective shield	Vertical front protection shield, pneumatically raisable/lowerable (cannot be combined with UTK 18.08)	UTK 18.04
Full protection cover	mounted above the saw table	UTK 18.05
Laser cutting line indicator	laser beam with approx. 300 mm line length	UTK 18.06
Spraying device	Micro Cooler - for cutting aluminium	UTK 18.07
Horizontal clamping device	2 pieces front horizontal pneumatic clamps (cannot be combined with UTK 18.04)	UTK 18.08
Pneumatic feed with oil brake cylinder	(feed brake) - for light metal	UTK 18.09

Feed and stop roller conveyors with various measuring and stop systems for safe material support and perfect cuts can be found on <https://beck-maschinenbau.com/en/products/roller-measuring-conveyors/>.

14.4 UTK 600

14.4.1 Circular saw blades

Article	Description	Art. No.
HM circular saw blade for wood	600 x 5.7 x 4.0 x 35 Z110 WZ	UTK 17.02-H
HM saw blade for aluminium	600 x 4.6 x 4.0 x 35 Z138	UTK 17.02-ALU

14.4.2 Options and accessories

Article	Description	Art. No.
Pneumatic protective shield	Vertical front protection shield, pneumatically raisable/lowerable (cannot be combined with UTK 17.08)	UTK 17.03
Full protection cover	mounted above the saw table	UTK 17.04
Laser cutting line indicator	laser beam with approx. 300 mm line length	UTK 17.05
Spraying device	Micro Cooler - for cutting aluminium	UTK 17.06
Pneumatic feed with oil brake cylinder	(feed brake) - for light metal	UTK 17.07
Horizontal clamping device	2 pieces front horizontal pneumatic clamps (cannot be combined with UTK 17.03)	UTK 17.08

Feed and stop roller conveyors with various measuring and stop systems for safe material support and perfect cuts can be found on <https://beck-maschinenbau.com/en/products/roller-measuring-conveyors/>.

15 Disassembly and scrapping

When dismantling and scrapping the machine, the current EU regulations or the respective regulations and laws of the country of operation, which are prescribed for proper dismantling and disposal, must be observed. The aim is to dismantle the machine and its various materials and components properly, to recycle all possible parts and to dispose of non-recyclable components in the most environmentally friendly way.

	<p>Please pay particular attention to</p> <ul style="list-style-type: none"> • <i>the dismantling of the machine in the working area</i> • <i>proper dismantling of the machine and accessories</i> • <i>a safe and proper removal of the machine</i> • <i>proper separation of all components and materials.</i>
---	--

When dismantling and disposing the machine, the laws and regulations in force at the place of use concerning health and environmental protection must be observed.

	<p>Remove all residues of oil, grease and other lubricants and have them disposed of properly by a qualified disposal company.</p>
---	---

When separating, disposing of or recycling the machine materials, comply with the environmental protection laws in force at the place of use regarding the disposal of industrial solid waste toxic and hazardous waste.

	<ul style="list-style-type: none"> • <i>Hoses and plastic parts as well as other components that are not made of metal must be dismantled and recycled or disposed of separately.</i> • <i>Electrical components such as cables, switches, connectors, transformers, etc. must be removed and (if possible) recycled or otherwise disposed of in a qualified manner.</i> • <i>Pneumatic and hydraulic parts such as valves, solenoid valves, pressure regulators, etc. must be removed and (if possible) recycled or otherwise disposed of in a qualified manner.</i> • <i>Dismantle the base frame and all metal parts of the machine and sort them according to material type. Metals can be melted down and recycled.</i>
--	--

In the event of improper disposal of lubricants, the following residual risks to the environment and health exist:

	<p>Pollution of the environment by seepage into groundwater or sewage system.</p>
---	--

	<p>Poisoning of the personnel contracted for the disposal.</p>
---	---

Note: The disposal of lubricants considered toxic and hazardous must be carried out in accordance with the regulations and laws in force at the respective place of use. Only qualified disposal companies that have the appropriate permits for the disposal of used oil and lubricants are to be commissioned with the disposal.

CE EU - Declaration of Conformity

in accordance with the EU Machinery Directive 2006/42/EC Annex II A

The manufacturer,

Reinhold Beck Maschinenbau GmbH
Im Grund 23
DE 72505 Krauchenwies

Telefon: +49 (0) 7576 / 962 978 - 0
Telefax: +49 (0) 7576 / 962 978 - 90

hereby declares that the manufactured machine

UNDER-TABLE CROSS-CUT SAW UTK 350, UTK 450, UTK 500, UTK 600

Machine-No.:

Year of manufacture:

in the version provided complies with the following directives:

- Machinery Directive 2006/42/EC
- EMC Directive 2014/30/EU

The notified body (0392)

DGUV Test
Prüf- und Zertifizierungsstelle Holz
Fachbereich Holz und Metall
Vollmoellerstraße 11
70563 Stuttgart (Germany)

Mr. Andreas Ganter, Graf-Stauffenberg-Kaserne, Binger Str. 28 | Halle 120, in
72488 Sigmaringen (Germany), is authorised to compile the technical documentation.

Krauchenwies, 14/03/2024
.....



.....
Reinhold Beck
Managing Director