

TRANSLATION OF THE ORIGINAL VERSION

CE



Operating Manual

Roller and measuring conveyors

EXAKT MES



Types for EXAKT MES: **A, C, B/KF and E/KF (track width 300 - 500 mm)**

Reinhold Beck Maschinenbau GmbH

Im Grund 23 | DE -72505 Krauchenwies

Tel.: +49 (0) 7576 / 962 978 - 0 | Fax: +49 (0) 7576 / 962 978 - 90

E-Mail: info@beck-maschinenbau.de | Web: <https://www.beck-maschinenbau.de>

Table of contents

1	Introduction.....	5
1.1	Legal notice.....	5
1.2	Illustrations.....	5
2	Symbols	5
2.1	General Symbols.....	5
2.2	Symbols in Safety Instructions.....	6
3	General	7
3.1	Features	7
3.2	Application.....	7
3.3	Target group and previous experience.....	7
3.4	Requirements for the operators.....	7
3.5	Accident prevention	8
3.6	General safety regulations.....	8
4	Safety.....	9
4.1	Basic safety instructions	9
4.2	Application area and intended use.....	9
4.3	Improper use	9
4.4	Consequences in case of disregard.....	10
4.5	Conversions and modifications of the roller conveyor.....	10
4.6	Supplementary safety equipment	10
4.7	Personal protective equipment.....	10
4.8	Residual risks	11
4.9	Observe the Environmental Protection Regulations	12
4.10	Organisational measures	12
4.11	Personnel selection and qualification - basic duties.....	12
5	Types and product description.....	13
5.1	EXAKT MES C.....	13
5.2	EXAKT MES A	14
5.3	EXAKT MES B/KF and E/KF	15
6	Technical specifications.....	16
6.1	Manufacturer	16
7	Transport to the installation site.....	17
7.1	Unloading with a forklift truck.....	17
7.2	Check delivery condition	17
7.3	Unpacking and placing.....	17
7.4	Transport to the place of use	18
7.5	Requirements for the installation site.....	18

7.6	Temporary storage	18
7.6.1	Short term storage	18
7.6.2	Long term storage	18
7.7	Lashing on a transport vehicle	18
8	Installation	19
8.1	Setting up the roller conveyor	19
8.1.1	Moving the roller conveyor to the place of use	19
8.1.2	Aligning and levelling the roller conveyor	20
8.1.3	Joining roller conveyor segments together	20
8.2	Anchoring in the ground	21
8.3	Installing the measuring tape for the stop system	22
8.4	Installing the magnetic tape for position measurement	23
8.4.1	Magnetic tape installation with EXAKT MES A	23
8.4.2	Magnetic tape installation with EXAKT E/KF	23
8.5	Connecting the roller conveyor (EXAKT MES A only)	24
8.6	Presetting the stop system (EXAKT MES A only)	24
8.6.1	Defining the zero point	24
8.6.2	Adjusting the height	24
8.6.3	Adjusting the 90° angle	24
8.7	Referencing the stop system (EXAKT MES A and E/KF only)	25
8.8	Operational readiness of the roller conveyor (EXAKT MES A only)	25
9	Operating the stop system (EXAKT MES A only)	26
10	Troubleshooting	27
11	Maintenance and repair	28
12	Supplementary documents	28
12.1	EXAKT MES A	28
12.2	EXAKT MES E/KF	28
13	Disassembly and scrapping	29
14	Machine card	30
15	Options and accessories	31
15.1	Accessories for all EXAKT MES versions	31
15.2	Accessories for EXAKT MES A	31
	Installation declaration for the component (as an incomplete machine)	32

List of figures

Figure 1: Roller conveyor EXAKT MES C	13
Figure 2: Roller and measuring conveyor EXAKT MES A	14
Figure 3: Roller and measuring conveyors EXAKT MES B/KF and E/KF	15
Figure 4: Lifting from the pallet with forklift truck	19
Figure 5: Moving the roller conveyor to the place of use with a lift truck.....	19
Figure 6: Levelling feet	20
Figure 7: Connecting flat bar and segments	20
Figure 8: Flat bar for BK/F and E/KF	20
Figure 9: Fitting the chain guide tube	21
Figure 10: Chain deflection	21
Figure 11: Fitting and tensioning the link chain	21
Figure 12: Measuring tape alignment EXAKT B/KF	22
Figure 13: EXAKT B/KF roller measuring conveyor with ready-glued measuring tape	22
Figure 14: Magnetic tape installation with EXAKT MES A	23
Figure 15: Magnetic tape installation with EXAKT E/KF.....	23
Figure 16: Defining the zero point of the stop system.....	24
Figure 17: Adjusting the height of the stop system	24
Figure 18: Adjusting the 90° angle of the stop system	24
Figure 19: Controls of the stop system	26
Figure 20: Lever for clearance stroke (option SZ 05)	26
Figure 21: Fold the stop arm backwards.....	26

Revisions:

Revision	Autor	Modification	Date
000	AG	Original manual translated	04.07.2023
001	AG	Sections 7.1 and 8.1.2 reworded. Last page changed to "Installation declaration".	12.09.2023

1 Introduction

The information in this operating manual enables safe, proper and economical operation of your roller conveyor. Please observe all the explanations, notes and regulations

- to avoid dangers and malfunctions,
- to reduce repair costs and downtimes
- and to increase reliability and service life

of your roller conveyor.

The operator must ensure that this operating manual is read by the persons entrusted with the operation, maintenance and repair of the roller conveyor. This operating manual as well as any appendices and additional documents must be kept easily accessible at the roller conveyor's place of use.

	<p><i>Ignorance or non-observance of these operating instructions may result in certain accident hazards during <u>handling</u> with the roller conveyor. Before commissioning, this operating manual and any appendices and additional documents must be read thoroughly. All instructions, in particular the safety regulations, must be observed!</i></p> <p><i>Handling</i> the roller conveyor in the sense of these instructions means</p> <ul style="list-style-type: none"> • the installation and commissioning, • the operation and proper usage, • the influence on operating conditions, as well as the maintenance, troubleshooting and repair.
---	---

Apart from the operating manual and the legally binding accident prevention provisions applicable in the country and place of use, the recognized technical regulations for safe and proper work must also be observed.

1.1 Legal notice



All contents of these operating instructions are subject to the rights of use and copyright of Reinhold Beck Maschinenbau GmbH. Any reproduction, modification, further use and publication in other electronic or printed media, as well as their online publication, requires the prior written consent of Reinhold Beck Maschinenbau GmbH.

1.2 Illustrations

All photos, figures and graphics contained in this document are for illustration and better understanding only and may differ from the current state of the product.

2 Symbols

2.1 General Symbols

Symbol	Meaning
	Indicates passages within this operating manual that must be particularly observed in order to prevent malfunctions or damage to the roller conveyor.
	Refers to chapters, sections, or figures within this document.
	Refers to an external document or a third-party source.

2.2 Symbols in Safety Instructions

Safety instructions are provided with corresponding danger symbols which have the following meanings:

Symbol	Safety Instruction
	Reading and applying the operating manual is mandatory for the operating personnel. <i>Failure to abide by the following precautions could lead to serious or fatal injury.</i>
	General danger symbol, which requires the highest attention! <i>Failure to observe may result in damage to the equipment, acute injury or even death.</i>
	Reference to a prohibited zone under a lifted load! <i>Do not enter! There is an increased risk of injury or even death.</i>
	Reference to a prohibited zone on a platform! <i>Do not enter! There is an increased risk of injury or even death.</i>
	Reference to a possible crushing hazard! <i>Non-observance increases the risk of injury to hands and fingers!</i>
	Reference to a possible crushing hazard! <i>Non-observance increases the risk of injury to feet and toes!</i>
	Possible dangerous crushing hazard in the area of stationary objects! <i>Risk of personal injury and additional equipment damage.</i>
	Reference to a hazard due to forklift traffic! <i>Non-observance can result in life-threatening injuries.</i>
	Reference to a danger under suspended loads! <i>Non-observance can result in life-threatening injuries.</i>
	Reference to tripping and slipping hazards on the floor! <i>Non-observance may result in minor or severe injuries.</i>
	Reference to possible environmental pollution! <i>Non-observance poses a risk of pollution of the environment and groundwater!</i>
	Reading and applying the operating manual is mandatory for the operating personnel. <i>Non-observance of the above precautions can lead to serious or fatal injuries.</i>
	Note on the obligation to wear tight-fitting protective work clothing! <i>Non-observance may result in increased risk of injury or even death!</i>
	Reference to the obligation to wear safety shoes resp. protective gloves! <i>Non-observance may result in increased risk of injury to feet & toes or hands & fingers!</i>
	Note on the obligation to wear protective goggles/face protection resp. hearing protection! <i>Non-observance increases the risk of injury to eyes/face resp. ear canals.</i>
	Note on the obligation to wear a dust protection resp. respiratory mask! <i>Non-observance increases the risk of injury to the respiratory tract.</i>
	Note on the obligation to wear a safety helmet! <i>Non-observance may result in increased danger of head injuries or even death!</i>
	Fire hazard! Do not smoke and do not ignite open fire.
	Access for unauthorized persons prohibited! <i>Risk of personal injury and additional equipment damage.</i>

3 General



The operating manual must be read carefully and understood before handling the roller conveyor! If anything is unclear, please contact the manufacturer.

The roller and measuring conveyors of the EXAKT MES series have been specially developed for heavy-duty use in metal and mechanical engineering. Support rollers made of metal with a wall thickness of 3 mm and a diameter of 89 mm are embedded in the frame construction made of high-quality and carefully welded steel. This enables a high load capacity of up to 450 kg per meter of roller conveyor. Thanks to the open design, loading by cranes is also possible.

The sliding stop positioning is precise and fast and (depending on the model) can be done manually or by hand-wheel adjustment. On the models equipped with a measuring system, the set dimension can be read off via a mm-scale or digital indicator (depending on the model). For type A with digital handwheel, an additional position indicator mounted at eye level is available as an option.

3.1 Features

- 450 kg loading capacity per meter of roller conveyor
- Working height 880 mm (feet height adjustable by ± 60 mm)
- Roller conveyor lengths 1 to 10 meters (special lengths available)

3.2 Application

The roller conveyor can be used for all work that corresponds to its intended use in section \Rightarrow 4.2. The roller conveyor is suitable for fencing and transporting workpieces in order to bring them into a specific position for machining. The roller conveyor must not be used for pushing or pulling workpieces.

- The roller conveyor must not be used for work that does not correspond to its intended use (see \Rightarrow 4.2).
- The roller conveyor is intended exclusively for commercial use.

3.3 Target group and previous experience

This operating manual is intended for the operating and maintenance personnel of the roller conveyor. The operating personnel is to be determined by the operator and must further meet the following requirements:

- Basic technical and mechanical knowledge as well as knowledge of the associated technical terms
- Reading and understanding these operating and maintenance instructions

In order to acquire the knowledge required to operate this roller conveyor, the operator must ensure the following measures:

- Product training for every operator (also possible external personnel)
- Regular safety instruction

3.4 Requirements for the operators

- ⚠ The operator is responsible for the safe use of the roller conveyor!
- ⚠ The roller conveyor may only be operated by trained personnel who have also read this manual.
- ⚠ Inspection, maintenance, cleaning and repair may only be performed by technical specialists with product-specific training and mechanical and/or electrical training.
- ⚠ Specialists with product-specific training are to be commissioned and held responsible for planning and checking the work.
- ⚠ The national protective regulations for employees must be observed
- ⚠ The legal minimum age must be observed.

3.5 Accident prevention

To avoid accidents, the following rules must be observed for operation:

- ⚠ Prevent unauthorised persons from having access to the roller conveyor.
- ⚠ Keep unauthorized persons away from the danger areas.
- ⚠ Repeatedly inform other persons present about existing residual risks (see ⇒ 4.8).
- ⚠ Conduct recurring training and instructions for persons who have to be in the area of the roller conveyor, which are also recorded.
- ⚠ New employees must be trained internally for working on a roller conveyor and this training must be documented.
- ⚠ It is forbidden to enter the roller conveyor or to climb or sit on the roller conveyor.

3.6 General safety regulations

In general, the following safety regulations and obligations apply when handling the roller conveyor:

- ⚠ The roller conveyor may only be operated when in perfect working order.
- ⚠ It is prohibited to remove, modify, bypass or bypass any protective, safety or monitoring device.
- ⚠ Defective or missing safety devices must be repaired resp. replaced immediately by authorised qualified personnel! The roller conveyor must not be operated during this time!
- ⚠ It is forbidden to modify or change the roller conveyor without the written approval of the manufacturer / supplier.
- ⚠ Malfunctions or damage must be reported to the operator immediately. In case of malfunctions, proceed as follows: Take the roller conveyor out of operation, eliminate the cause of the malfunction, eliminate the malfunction, check the roller conveyor for safe condition and only then put it back into operation!
- ⚠ Repair and maintenance work on electrical and pneumatic components may only be carried out by authorised and trained personnel.
- ⚠ Maintenance work must be carried out and documented according to the maintenance instructions.
- ⚠ Only original spare parts from the roller conveyor manufacturer may be used for repairs.
- ⚠ Additional electronic components may only be purchased from the roller conveyor manufacturer.
- ⚠ Only instructed, trained or qualified persons may work on and with the roller conveyor.
- ⚠ It is not permitted to enter the roller conveyor or to transport persons.
- ⚠ For the operation of the roller conveyor, the respective national safety regulations for employees as well as the national safety and accident prevention regulations apply.

4 Safety

4.1 Basic safety instructions

Roller conveyors can cause hazards if used improperly. Therefore, observe the safety instructions listed in this chapter and the accident prevention regulations of your employer's liability insurance association!



The manufacturer accepts no liability for damage and malfunctions resulting from failure to observe these operating instructions.

4.2 Application area and intended use

With their conformity to the Machinery Directive 2006/42/EC, the roller conveyors of the EXAKT series are suitable as technical aids for operational/commercial applications.



Improper use may endanger persons and lead to a defect or damage. and to a defect or damage of the roller conveyor.

- ⚠ The roller conveyor is primarily intended for operation in covered indoor areas.
- ⚠ The roller conveyor is suitable for transporting workpieces to a specific holding position before machining.
- ⚠ Work on the roller conveyor may only be carried out in sufficiently illuminated working areas.
- ⚠ The maximum load capacity (refer to section ⇒ 6) of the roller conveyor must not be exceeded.
- ⚠ The roller conveyor may only be operated on horizontal floors.
- ⚠ The roller conveyor is not intended for moving and transporting persons.
- ⚠ The roller conveyor must not be operated in potentially explosive working areas.
- ⚠ Any other use is considered improper and is prohibited.

4.3 Improper use



Improper use is when the roller conveyor is used for purposes other than those prescribed in this operating manual and in section ⇒ 4.2, for example

- ⚠ use and application for private or non-commercial purposes,
- ⚠ use in disregard of the regulations in the operating manual,
- ⚠ use after unauthorized conversions or modifications,
- ⚠ exceeding the maximum permissible load (refer to section ⇒ 6)
- ⚠ non-compliance with the permissible workpiece dimensions.
- ⚠ transporting persons or stepping on the roller conveyor
- ⚠ or feeding or pulling of workpieces.

In case of improper use of the roller conveyor, any warranty, liability and other claims for damages of the operator against the manufacturer are excluded!





4.4 Consequences in case of disregard

If the roller conveyor is not operated, maintained or repaired in accordance with the safety regulations, not as intended, improperly or in an abusive manner, the following will result:

-  Dangers to the health of the operating personnel
-  Dangers to the roller conveyor and objects in its vicinity
-  Impairment of the roller conveyor function

In case of improper use of the roller conveyor, any warranty, liability and other claims for damages of the operator against the manufacturer are excluded!

4.5 Conversions and modifications of the roller conveyor

-  Only use the roller conveyor in its original condition, i.e. as delivered!
-  The components of the roller conveyor must not be changed in their type and condition.
-  Only original spare parts and accessories from the manufacturer (see ⇨ 15) may be used.
-  Deviations are not permitted.







	<i>Unauthorized modifications or conversions by the operator, without the written consent of the manufacturer, are prohibited. This excludes any warranty, liability and other claims for damages by the operator against the manufacturer!</i>
---	--

4.6 Supplementary safety equipment

	<i>The functionally safe provision and installation of supplementary machine protection fences and protective grilles for the roller conveyor supplied is the responsibility of the operator! These measures are not part of the scope of delivery of Reinhold Beck Maschinenbau GmbH.</i>
---	---















4.7 Personal protective equipment

To minimise the risk of injury in case of danger, personal protective equipment must be worn when working on and with the roller conveyor. The operator of the roller conveyor is obliged to wear the protective equipment required for the respective work!

	Close-fitting protective clothing with low tear resistance, tight sleeves and no protruding parts must be worn for all work on and with the roller conveyor. The main purpose is to protect against being caught by moving parts of the installation. Do not wear watches, rings, chains or other jewellery. Wearing long open hair is prohibited during work.
	Safety shoes with non-slip soles must be worn for all work on and with the roller conveyor. These serve to protect against falling parts and at the same time to prevent slipping on slippery surfaces.
	Wearing protective gloves serves to protect the hands from abrasions, puncture wounds or deeper injuries, as well as from irritating and corrosive substances and from burns.
	Hearing protection protects the hearing from the effects of noise that is harmful to health. As soon as the workplace-related noise emission values exceed 85 dB(A), personnel must be provided with suitable hearing protection!
	Safety goggles protect the eyes from injuries caused by dust, chips and flying off parts on a processing machine as well as from compressed air and irritating resp. corrosive or toxic liquids.
	A respiratory respirator resp. dust mask protects the respiratory tract from respiratory air contamination (e.g. from wood dust or similar) and from toxic exhaust gases (e.g. from a forklift truck).
	The safety helmet serves to protect against falling parts and head injuries. It is mandatory to wear a safety helmet especially when unloading the roller conveyor by means of a forklift truck.

4.8 Residual risks

The roller conveyor is built according to the latest state of the art and the recognised safety rules. Nevertheless, the use of the roller conveyor may cause danger to life and limb of the user or third parties or damage to the roller conveyor and other equipment. Due to the construction of the roller conveyor, the following residual risks can occur even when used as intended and despite compliance with all relevant safety regulations:

	<p>The operating personnel must read and apply the operating manual. Furthermore, the operating manuals of additional third-party components must be observed.</p>
 	<p>Be alert to possible crushing hazards:</p> <p>a) when transporting the roller conveyor by forklift truck: between forks & pallet / roller conveyor b) when picking up the roller conveyor: between roller conveyor / pallet and floor c) when lowering the roller conveyor: between roller conveyor and fixed equipment</p> <p>In addition, be aware of possible crushing hazards when setting down the roller conveyor (from the freight pallet to the ground) using a forklift truck. Wearing protective gloves and safety shoes is mandatory when transporting and setting up the roller conveyor.</p>
	<p>Toxic exhaust gases are produced by forklift trucks or comparable vehicles with combustion engines. Generally wear a respiratory protection mask in working environments with the above-mentioned exhaust gas development.</p>
	<p>Be aware of the danger from falling objects such as workpieces, tools or similar. Therefore wear safety shoes, especially when transporting and setting up the roller conveyor.</p>
	<p>Riding on the roller conveyor during a lifting operation (by forklift truck or indoor crane) is prohibited. There is a risk of falling!</p>
	<p>Increased risk of injury or even death. Entering the danger zone under a suspended load during transport or installation by means of a forklift truck is prohibited! Generally wear a safety helmet in working environments with suspended loads.</p>
	<p>Increased risk of injury or even death. It is forbidden to enter the forklift platform during transport or installation!</p>
	<p>Unauthorised persons are not allowed to enter the installation area of the roller conveyor. Compliance with this regulation is the responsibility of the operator.</p>
	<p>Danger of electric shock on models with digital position indicator! Work on the electrical components may only be carried out by qualified personnel.</p>
	<p>Be aware of tripping and slipping hazards on the floor. Prevent hazards by keeping the floor dry and clean and by using anti-slip floor coverings around the roller conveyor.</p>
	<p>Risk of injury due to crushing, jamming as a result of reaching between moving parts! There is an increased risk of accidents with loss of limbs or even death. Observe the handling instructions and follow the warnings! Wear protective gloves if necessary.</p>
	<p>Risk of injury from compressed air components! Do not exceed the permissible operating pressure (max. 6 bar)! Wear protective goggles when handling compressed air.</p>
	<p>When using additional machines on the roller conveyor, read the respective operating manual of the machine used beforehand and comply with the safety instructions contained therein.</p>
	<p>Be aware of the fire hazard during the processing of wood due to wood dust, in connection with flying sparks and/or open fire!</p>

4.9 Observe the Environmental Protection Regulations

During all work with the roller conveyor, the environmental protection regulations, obligations and laws for waste avoidance and proper recycling and/or disposal applicable at the place of use must be observed. This applies in particular to installation, repair and maintenance work involving substances that could pollute the groundwater (e.g. hydraulic oils and cleaning agents and liquids containing solvents). In any case, prevent them from seeping into the ground or entering the sewage system.

	<p>Store and transport the above-mentioned hazardous substances only in suitable containers. Avoid leakage of hazardous substances by using suitable collection containers. Ensure that the above-mentioned substances are disposed of by a qualified disposal company.</p>
---	--

4.10 Organisational measures

- ⚠ Always keep this operating manual within easy reach and at the place of use of the roller conveyor.
- ⚠ In addition to the operating manual, observe and instruct on applicable legal and other binding regulations for accident prevention and environmental protection.
- ⚠ Supplement the operating manual with further instructions, including supervisory and reporting duties, to take account of special operational features (e.g. with regard to work organisation, work processes, personnel employed).
- ⚠ Before starting work on the roller conveyor, the person responsible for its operation must have read the operating instructions, especially the chapter "Safety". This applies in particular to personnel who only occasionally work on the roller conveyor.
- ⚠ Check that work is carried out in a safety-conscious and hazard-conscious manner and in compliance with the operating manual.
- ⚠ When using additional machines on the roller conveyor, read the respective operating instructions and keep them handy. Pay particular attention to the respective safety and hazard information.
- ⚠ In case of safety-relevant changes to the roller conveyor or its operating behaviour, shut down the entire system immediately and report the fault to the responsible office/person.
- ⚠ Use personal protective equipment as necessary or required by regulations (see section ⇨ 4.7).
- ⚠ Do not make any modifications, additional attachments or conversions to the roller conveyor without the manufacturer's approval! This will compromise safety and invalidate the manufacturer's warranty and any liability claim.
- ⚠ Spare parts must meet the technical requirements specified by the manufacturer. The exclusive use of original spare parts ensures this. Therefore, only use original spare parts from the manufacturer.
- ⚠ Observe the fire alarm and firefighting possibilities. Make the location and operation of fire extinguishers (fire class ABC) known. Do not use water!

4.11 Personnel selection and qualification - basic duties

- ⚠ The design and operation of the roller conveyor is equally suitable for right- and left-handers.
- ⚠ The roller conveyor is designed to be operated by a single person. Other persons in the vicinity of the roller conveyor must keep a suitable safety distance.
- ⚠ Work on and with the roller conveyor may only be carried out by reliable personnel. Observe the legal minimum age!
- ⚠ Only use trained or instructed personnel. Clearly define the responsibilities of the personnel for operating, setting up, maintaining and repairing!
- ⚠ Ensure that only authorised personnel work on the roller conveyor.
- ⚠ If personnel to be trained or apprenticed have to work on the roller conveyor, this may only be done under the constant supervision of an experienced resp. qualified person.
- ⚠ Work on pneumatic equipment of the roller and measuring conveyor may only be carried out by authorised and trained personnel.
- ⚠ Work on electrical equipment may only be carried out by a qualified electrician or by instructed persons under the direction and supervision of a qualified electrician in accordance with the electrotechnical rules.

5 Types and product description

5.1 EXAKT MES C

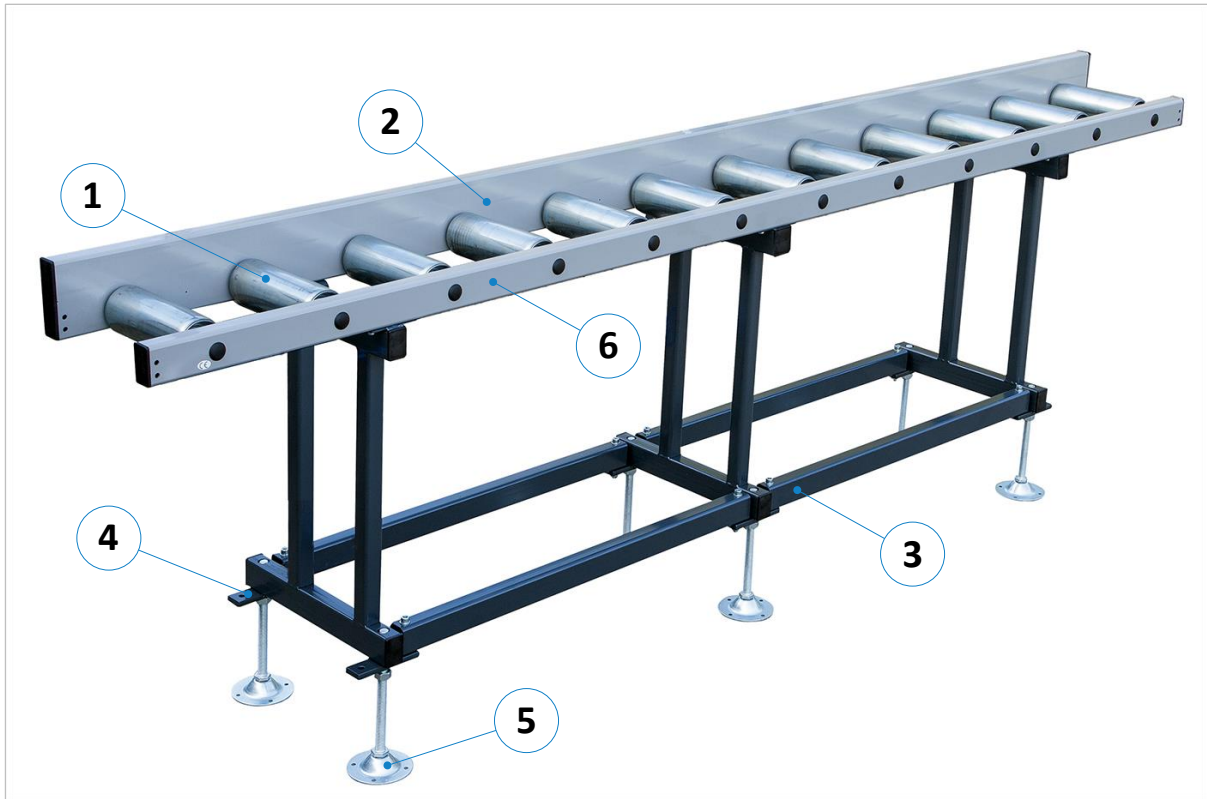

Figure 1: Roller conveyor EXAKT MES C

Pos.	Description	Pos.	Description
1	Carrying roller	4	Base plate
2	Rear support rail	5	Adjustable foot
3	Spacer rail	6	Front support rail

The roller conveyors in the basic version EXAKT MES C (see ⇒ Figure 1) are pure infeed/outfeed roller conveyors without dimensional scale and stop system. At the same time, it represents the basic version of the EXAKT MES series.

The roller conveyors consists of the support rails (2) and (6) with a track width of 300, 400 or 500 mm and the reinforced carrying rollers (1) made of steel with a diameter of 89 mm and a load capacity of 450 kg / meter of roller conveyor.

The base of the support rails consists of extra stable base plates (4) with screwed-in spacer rails (3). The roller conveyor can be adjusted in height resp. levelled with a machine spirit level via the adjustable feet (5). The adjustment range for the height adjustment is ± 60 mm.

Optional equipment:

- Cover plates for the carrying rollers
- For further options, see chapter ⇒ 14 “Options and accessories”

5.2 EXAKT MES A

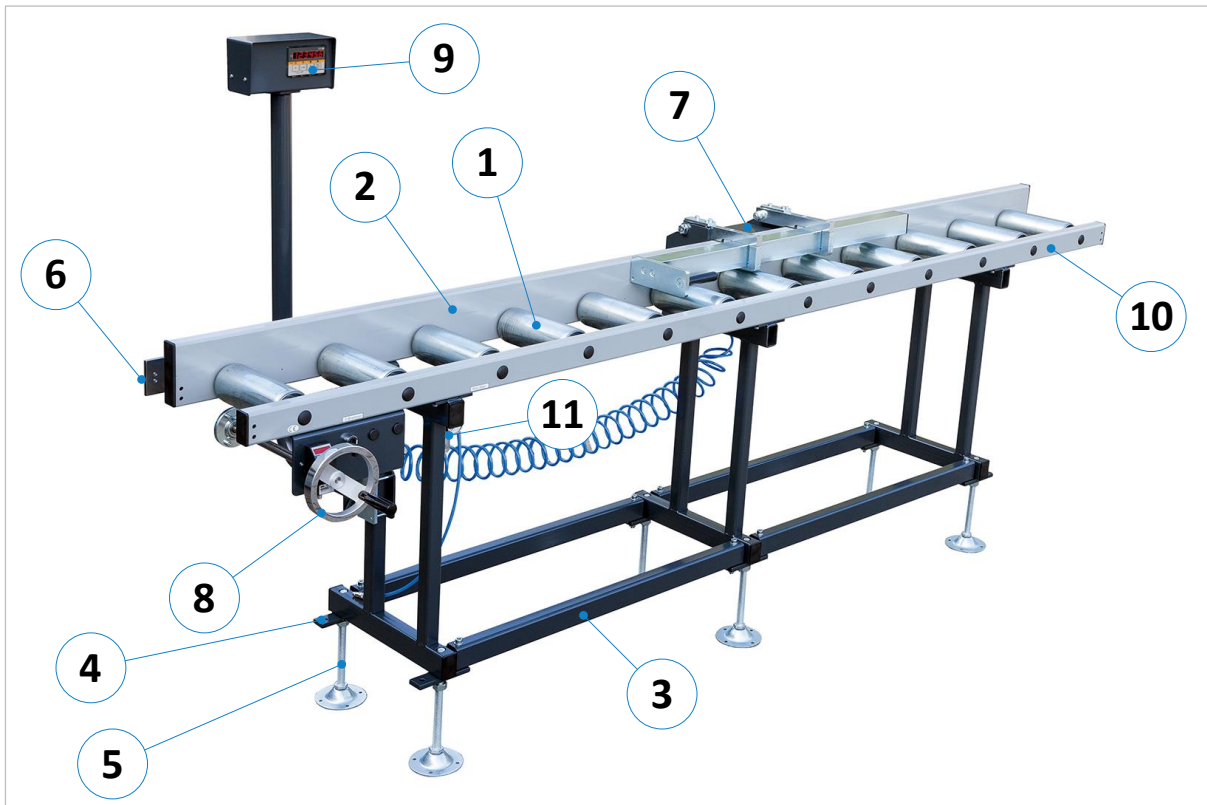

Figure 2: Roller and measuring conveyor EXAKT MES A

Pos.	Description	Pos.	Description
1	Carrying roller	7	Stop slider
2	Rear support rail	8	Handwheel with LED position indicator
3	Spacer rail	9	LED position indicator type Z58 (option)
4	Base plate	10	Front support rail
5	Adjustable foot	11	Compressed air connection
6	Precision guide profile		

The roller and measuring conveyors in the EXAKT MES A version (see ⇨ Figure 2) are based on the roller conveyor basic version EXAKT MES C (see section ⇨ 5.1).

Additional features in the standard version of these roller and measuring conveyors:

- Rear support rail (2) with precision guide profile (6) for the stop slider
- Sliding carriage (7) with fixed stop, 12-fold ball bearing, compressed air connection (11) and pneumatic brake
- Sliding carriage adjustable by handwheel (8) due to revolving chain
- Handwheel with LED position indicator

Optional equipment:

- Cover plates for the carrying rollers
- Spring-loaded stop arm with mechanical clearance stroke
- Spring-loaded stop arm adjustable to the 0-point of the processing machine and with mechanical arm retraction (optionally with pneumatic arm retraction / optionally with pneumatic folding-up device)
- Position indicator Z58 (9) at eye level, with rotary measurement via magnetic ring on handwheel axis
- Position indicator Z58 (9) at eye level, with linear measurement via magnetic tape on flat steel guide
- For further options, see chapter ⇨ 14 "Options and accessories"

5.3 EXAKT MES B/KF and E/KF

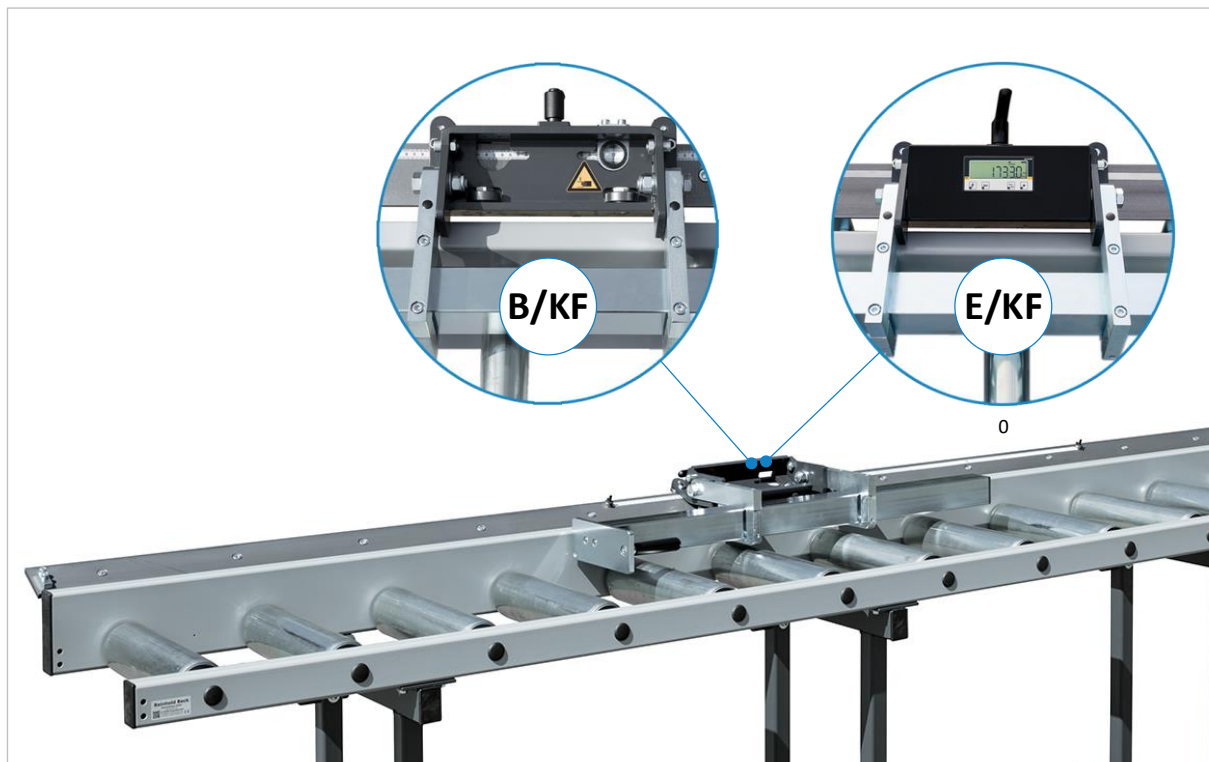

Figure 3: Roller and measuring conveyors EXAKT MES B/KF and E/KF

The roller and measuring conveyors in the EXAKT MES B/KF and EXAKT MES E/KF versions (⇒ Figure 3) are based on the roller conveyor basic version EXAKT MES C (see section ⇒ 5.1).

In addition, both types have a robust flip stop as well as a 6-fold ball bearing mounted sliding carriage that can be moved smoothly by hand to position the stop to the desired dimension. The two versions differ only in the type of manual length measuring system.

Measuring system for EXAKT MES B/KF	Measuring system for EXAKT MES E/KF
<ul style="list-style-type: none"> • Length measuring device with mm-scale and magnifying glass on the sliding carriage • Manual measuring system with stable precision flat steel guide • Measuring accuracy ± 0.5 mm per meter 	<ul style="list-style-type: none"> • With magnetic tape measuring system and battery-operated LCD display on the sliding carriage • Manual measuring system with stable precision flat steel guide • Measuring accuracy ± 0.1 mm per meter

Available options see chapter ⇒ 14 “Options and accessories”.

6 Technical specifications

General technical specifications	
Load per meter	450 kg
Roller conveyor length	1- 10 m (or customised special length)
Working height	880 mm
Height adjustment	± 60 mm via adjustable feet
Carrying rollers	galvanised steel tubes, roller- \varnothing = 89 x 3 mm, ball bearing, axle- \varnothing = 20 mm
Idler spacing	250 mm
Roller track width	300 / 400 / 500 mm
Usable roller width	250 / 350 / 450 mm
EXAKT MES A (roller and measuring conveyor)	
Length measuring system	<u>Standard:</u> Length measuring unit with handwheel adjustment directly on the hand-wheel and digital LED measuring display in mm (optionally 1/10 mm). <u>Optional:</u> Additional magnetic tape measuring system with Z58 LED position indicator
Energy chain guide	from 5 m track length (obligatory with option "magnetic tape measuring system Z58")
Measuring accuracy	± 0.5 mm per meter (standard) resp. ± 0.2 mm per meter (with option Z58)
Max. measuring length	= track length minus 450 mm
Stop system	Sliding carriage with 12 ball bearings and pneumatic brake, movable on large-dimensioned guide profile
Electrical connection	230 VAC / 50 Hz with power supply unit
Pneumatic connection	via quick coupling (operating pressure max. 6 bar)
EXAKT MES C (pure infeed/outfeed roller conveyor)	
Length measuring system	not equipped
Stop system	not equipped
EXAKT MES B/KF (roller and measuring conveyor)	
Length measuring system	Manually, via mm-scale and magnifying glass on the sliding carriage
Measuring accuracy	± 0,5 mm/m
Max. measuring length	= track length minus 400 mm
Stop system	robust flip stop with 6-fold ball bearing sliding carriage, smooth-running, manually adjustable and lockable
EXAKT MES E/KF (roller and measuring conveyor)	
Length measuring system	manually movable magnetic tape measuring system with battery-operated IZ17E LCD position indicator, mounted directly on the sliding carriage
Measuring accuracy	± 0,1 mm/m
Max. measuring length	= track length minus 400 mm
Stop system	robust flip stop with 6-fold ball bearing sliding carriage, smooth-running, manually adjustable and lockable

6.1 Manufacturer







Reinhold Beck Maschinenbau GmbH
 Im Grund 23
 DE-72505 Krauchenwies (Germany)
 Phone: +49 (0) 7576 / 962 978 - 0
 Fax: +49 (0) 7576 / 962 978 - 90
 Email: info@beck-maschinenbau.de

Note: Before using the unit in a way that deviates from the described suitability (see section ⇨ 4.2), it is essential to consult the manufacturer. Otherwise all warranty, liability and other claims for damages of the operator against the manufacturer will be voided!

7 Transport to the installation site

Only trained unloading personnel may be used for the work listed in this chapter!

Note: Roller conveyors longer than 6 meters are usually shipped in single segments and are packed either on two separate freight pallets or on top of each other.

	<p>There is an increased risk of accidents when unloading and transporting the roller conveyor! The roller conveyor can fall or tip over due to its weight!</p>
	<p>Only use approved, tested lifting gear and load handling attachments with a load capacity of at least <u>200 kg per meter</u> of roller conveyor length. Only transport the roller conveyor on level, solid ground!</p>
	<p>When setting up, pay attention to the possible danger of crushing in the area of stationary objects around the roller conveyor!</p>
	<p>Increased risk of crushing and impact to hands, feet and head! To avoid serious injuries, wear protective gloves, safety shoes and safety helmet!</p>
	<p>Warning: Increased risk of injury and death! Never stand under the load when lifting and setting it down! Instruct bystanders to leave the danger zone!</p>
	<p>Warning: Increased risk of injury and death! Do not enter or climb onto the forklift platform during transport!</p>

7.1 Unloading with a forklift truck

- With the forks set wide enough, drive centrally under the intended places on the freight pallet of the roller and measuring conveyor and carefully lift only a few centimetres. Lift the roller measuring conveyor including the pallet carefully and consistently from the truck and transport it to the desired installation site in accordance with the general safety regulations.
- Only use a forklift truck whose fork length is suitable for the width of the roller conveyor and whose load capacity is suitable for the weight of the roller conveyor (approx. 100 kg per meter of roller conveyor length).



	<p>Danger to life when using a forklift truck! Keep a sufficient distance from the forklift truck and watch its speed. Vehicles with internal combustion engines also produce toxic exhaust gases. Wear a breathing mask if necessary.</p>
---	---

7.2 Check delivery condition

Check for completeness and transport damage. In case of transport damage or missing parts, document these immediately on the consignment note of the transport company → Inform the manufacturer of the situation.

7.3 Unpacking and placing

Unpack the roller conveyor and remove the packaging material. Lift the roller conveyor from the transport pallet with a forklift truck. Drive under the centre of the long side of the roller conveyor with appropriately adjusted forks and lift carefully. Then lift carefully from the pallet, remove the pallet and place the roller conveyor on the ground.

	<p>Fire hazard! Do not smoke or light an open fire.</p>
	<p>Dispose of the packaging material in an environmentally friendly manner!</p>

7.4 Transport to the place of use

After unpacking, the roller conveyor can be moved to the installation site using a lift truck. When doing so, the general safety regulations must be followed and observed. For procedure refer to section ⇒ 8.1.1.

7.5 Requirements for the installation site

The following guidelines apply with regard to space requirements, load-bearing capacity and the condition of the substrate:

- Space requirements: L x H x W = Length according to customer requirements x 1800 x 700 mm
- Load capacity: Concrete of classification B 15
- Conditions: Level, smooth, non-slip and tilt-free

7.6 Temporary storage

If the roller conveyor is not put into operation immediately after delivery, it must be stored carefully in a protected place. Carefully cover the entire roller conveyor so that neither dust nor moisture can penetrate.

7.6.1 Short term storage

- Dry environment
- Protect components at risk of corrosion
- Park in a stable place

7.6.2 Long term storage

- Dry environment
- Protect components at risk of corrosion
- Protect roller conveyor from dirt
- Park in a stable place
- Dismantle roller conveyor into individual segments if required

7.7 Lashing on a transport vehicle

For further transport, the roller conveyor must be lashed to the loading area of the transport vehicle on a pallet. For this purpose, a sufficient number of lashing straps with the appropriate load-bearing capacity must be used.

The responsibility for safe loading is borne by the respective shipper!

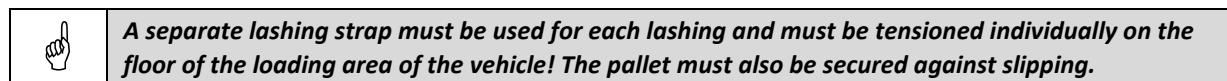

Please note the following when lashing in the transport vehicle:

- The loading area of the transport vehicle must always be clean and dry.
- The lashing straps used and their number must be suitable for the total weight of the roller conveyor and distributed accordingly. The weight is approx. 100 kg per meter of roller conveyor length.
- Loose and moving parts must be secured against slipping or packed in separate boxes if necessary.
- Fastening on the loading area is done by lashing down: This means that the transport pallet is secured by frictional locking. The load is pressed so firmly onto the loading surface that it can no longer slip. The clamping tool should have a high STF value at the frictional connection, e.g. long-lever ratchets.
- In addition, anti-slip mats should be used to provide even more safety.
- The ideal lashing angle (α) for tie-down lashing is 83° to and 90°. Therefore, the lashing straps should pull downwards approx. vertically. As the angle decreases, the pretensioning force of the lashing is reduced.
- Observe the permissible total weight of the transport vehicle.
- Ensure that the permissible axle loads of the transport vehicle are observed. The load must be distributed evenly on all axles of the vehicle.

8 Installation

The roller conveyor must be installed by a competent person. Make sure that the roller conveyor is stable and installed in such a way that no crushing or shearing points occur between the roller conveyor and objects in the vicinity. Therefore, ensure sufficient space around the roller conveyor in advance. When operating the roller conveyor as intended, it must always be possible to carry out activities on the roller conveyor without obstructions.



Before commissioning the roller conveyor, it must be levelled with a machine spirit level and anchored to the ground at the designated points by a competent person.

The following installation and operating requirements must be observed:

- ⚠ The roller conveyor must be integrated into the existing machinery in such a way that the basic safety requirements of the EU Machinery Directive 2006/42/EC are met. This must be checked and ensured by the operator of the roller conveyor.
- ⚠ The environment must not be explosive.
- ⚠ This operating manual and any supplementary documents must be read carefully and understood. All safety instructions and regulations must be observed and complied.



Note for EXAKT MES A: At the end of the installation, the power supply lines required for operation must still be routed to the roller conveyor in a hazard-free and proper manner.

8.1 Setting up the roller conveyor

The roller conveyor is lifted off the pallet by means of a forklift truck. Depending on the length of the roller conveyor, a second forklift truck is required to prevent the roller conveyor from bending and being damaged.

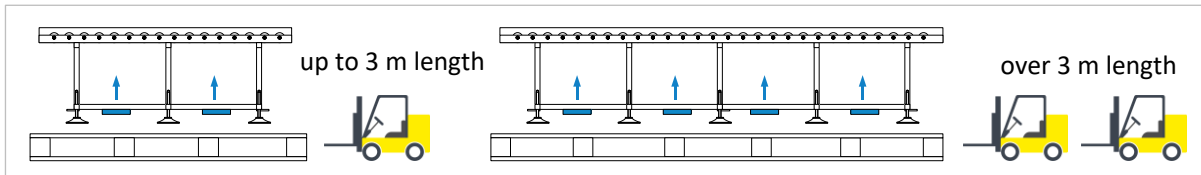

Figure 4: Lifting from the pallet with forklift truck

- For roller conveyors up to 3 meters long, one forklift truck is sufficient.
- Guide the appropriately spaced forks to the points marked in ⇒ Figure 4 (left).
- Then lift the roller conveyor only a few centimetres and park it in the immediate vicinity of the place of use.
- For lengths over 3 meters, two forklift trucks are required for the lifting process due to the weight.
- Guide the appropriately spaced forks to the points marked in ⇒ Figure 4 (right).
- Then lift the roller conveyor with both forklift trucks as consistently as possible and only a few centimetres to protect the mechanics at the joints. Now park the roller conveyor in the immediate vicinity of the place of use.

8.1.1 Moving the roller conveyor to the place of use

Then use one resp. two lift trucks to move the roller conveyor to the final place of use (e.g. processing machine) and feed the forks in at the marked points (see ⇒ Figure 5).

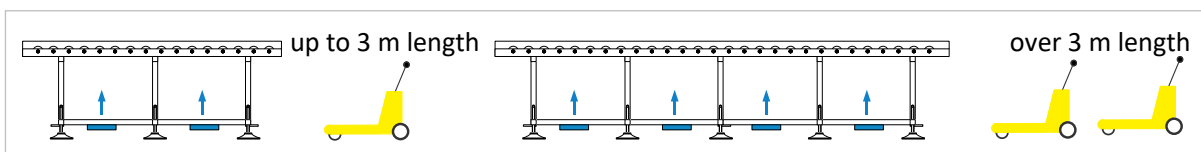

Figure 5: Moving the roller conveyor to the place of use with a lift truck

Make sure to use two lift trucks and to lift the roller conveyor consistently if it is longer than 3 meters. Then move the roller conveyor to the installation site and align it according to ⇒ 8.1.2.

8.1.2 Aligning and levelling the roller conveyor

To align the roller conveyor optimally to the processing machine, proceed as follows:

- Align the roller conveyor both in line and level with the existing processing machine. With a split roller conveyor EXAKT MES A, always start with the roller conveyor part on which the handwheel is mounted (right or left of the processing machine, depending on the roller conveyor configuration).
- An open-end spanner SW 30 is required for levelling and height adjustment.

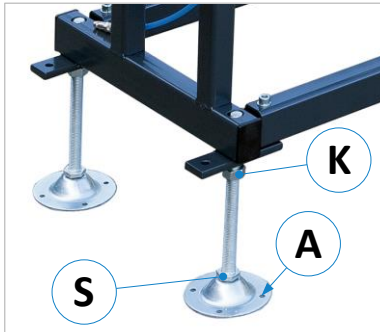

Figure 6: Levelling feet

- Adjust the feet so that the roller conveyor stands securely and horizontally on all levelling feet. Level the roller conveyor exactly with a spirit level and adjust it to the level of the processing machine. To do this, loosen the lock nut (K) and adjust the height with the set screw (S). Then tighten the lock nuts (K) again.
- Then firmly join the processing machine with the roller & measuring conveyor.
- Boreholes (A) see section ⇒ 8.2.

8.1.3 Joining roller conveyor segments together

In the case of a roller conveyor delivered in sections, the roller conveyor segments must be joined together.

- First align roller conveyor segment 1 correctly → Then place the roller conveyor segment 2 against the already aligned roller conveyor segment 1 and align it exactly to it.
- Afterwards the delivered roller conveyor segments must be connected to each other on the front and rear side with the two connecting lugs (L) by screwing them together (see ⇒ Figure 7).

EXAKT MES A:

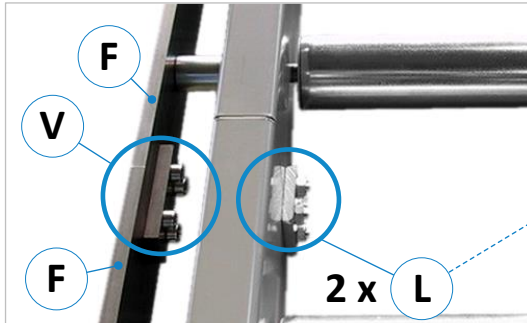

Figure 7: Connecting flat bar and segments

⇒ Figure 7: Screw the vertically mounted guide flat bars (F) of the roller conveyor tightly together with the screwed-on connecting bracket (V). When attaching the connecting bracket (V), make sure that the flat bars are exactly flush with each other → The air gap between the flat bars should be as small as possible.

EXAKT MES BK/F and E/KF:

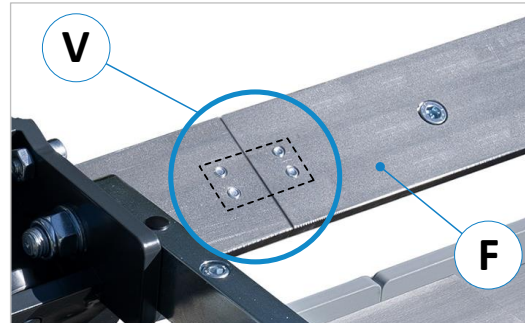

Figure 8: Flat bar for BK/F and E/KF

⇒ Figure 8: Screw the inclined mounted guide flat bars (F) of the roller conveyor tightly together with the screwed-on connecting bracket (V) from the rear side. When attaching the connecting bracket (V), make sure that the flat bars are exactly flush with each other → The air gap between the flat bars should be as small as possible.

- **Only EXAKT MES A:** The chain guide tubes (**R**) are simply pushed over the pre-mounted clamping plates (**P**) on the angle brackets (**W**) – see ⇒ Figure 9 - and then fixed in alignment using hexagon socket screws. The deflection (**U**) for the chain is mounted on the end pieces (see ⇒ Figure 10).

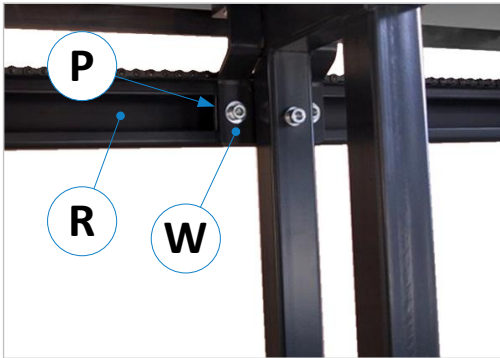

Figure 9: Fitting the chain guide tube

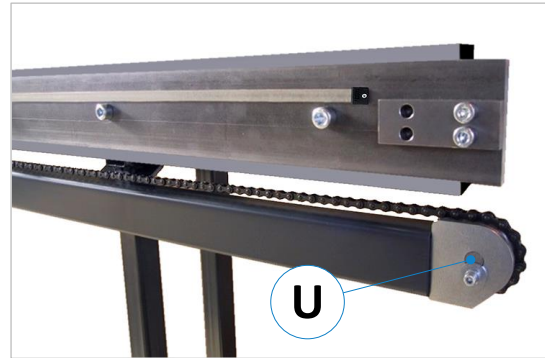

Figure 10: Chain deflection

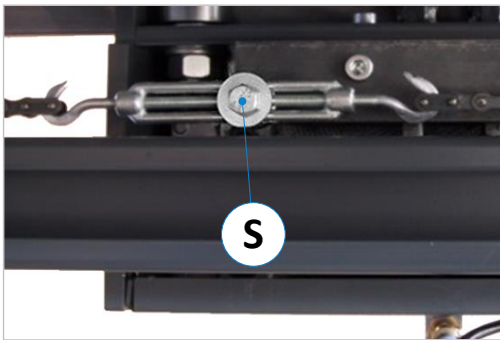

Figure 11: Fitting and tensioning the link chain

- The link chain supplied is guided around the chain wheels and hooked into the chain turnbuckle at both ends. To do this, the chain turnbuckle must first be removed from the sliding carriage using the screw (**S**).
- Then tension the chain so that it has a medium to strong tension according to the chain size. Please make sure that the chain is not turned.
- Then reassemble the chain turnbuckle to the sliding carriage with the screw (**S**).

8.2 Anchoring in the ground

When all parts are assembled and aligned to the machine, anchor the roller conveyor to the floor via the four holes (**A**) in the foot plates with heavy duty dowels (see ⇒ Figure 6).

8.3 Installing the measuring tape for the stop system

In order to turn the roller conveyor into a measuring conveyor, the measuring tape supplied loose with the **EXAKT MES B/KF** model must be glued to the flat bar guide and aligned with the reading magnifier.



Figure 12: Measuring tape alignment EXAKT B/KF

- Before gluing, clean the flat bar guide in the gluing area with a grease-dissolving agent.
- Determine the starting position of the scale so that it corresponds to your application and mark this position e.g. with a scribe.
- If necessary, cut the measuring tape to the length of your desired measuring range.
- Pass the measuring tape with the protective adhesive film not yet removed under the carriage.

- To define the height position, align the tape measure so that the scale is visible under the magnifying glass (see ⇒ Figure above) → Then mark the determined height position over the entire length at several positions with a scribe or similar or measure it.



Important: The distance of the measuring tape to the upper edge of the flat bar guide must be identical over the entire length.

- Then push the sliding carriage into the approximate centre of the roller conveyor.
- At first, only peel off the protective adhesive film at the initial position you have determined.
Important: Peel off the film only a little longer than the width of the sliding carriage.
- Align the height and initial position of the measuring tape with your markings/measurements and initially tape it only at this point (length of the protective adhesive film previously removed).
- Now move the sliding carriage over the already glued-on spot at the initial position
- Now you can apply the rest of the tape measure by peeling off the remaining protective film and using your markings/measurements as a guide when sticking it on.

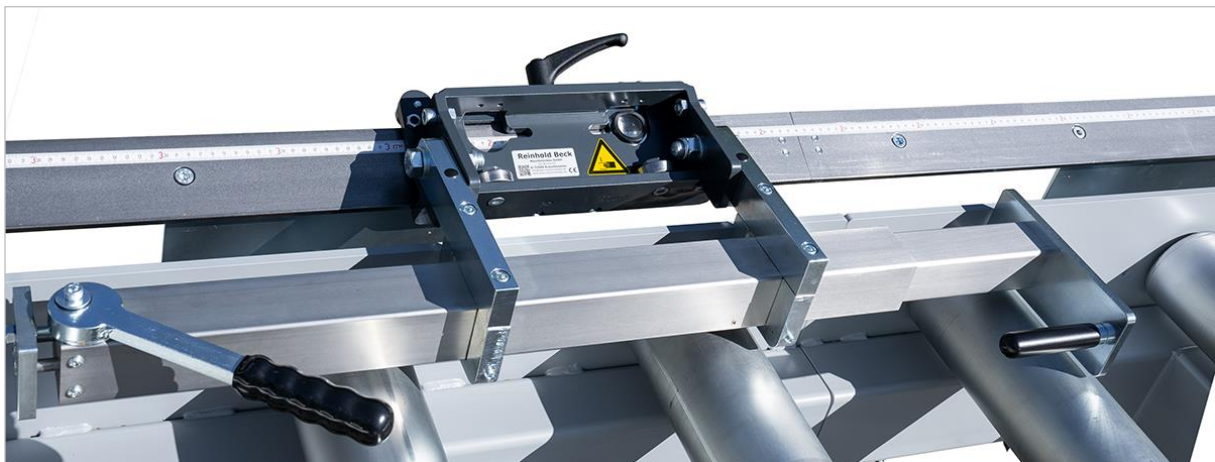



Figure 13: EXAKT B/KF roller measuring conveyor with ready-glued measuring tape

8.4 Installing the magnetic tape for position measurement

The magnetic tape supplied is stuck onto the guide flat bar of the stop roller guide - starting from the processing machine - at a distance of 18 mm from the upper edge of the flat bar. The magnetic tape contains the incremental coding for position detection of the stop system. In order to achieve the maximum measurement accuracy, the magnetic tape may only be applied after the roller conveyor has already been set up, aligned and anchored.

	<p>The magnetic tape must not be rolled up tightly or bent, otherwise it will be destroyed.</p> <p>The magnetic tape must not be exposed to direct contact with other magnetic fields (e.g. magnetic metal parts, electromagnets, holding magnets or similar). The influence of foreign magnets will destroy the coding, falsify the measurement result and render the magnetic tape unusable.</p>
---	--

8.4.1 Magnetic tape installation with EXAKT MES A

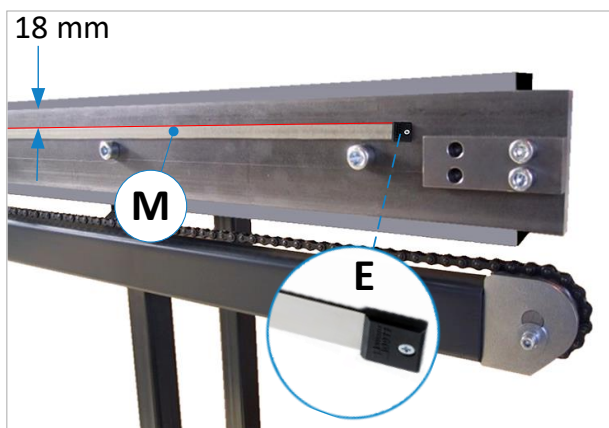

Figure 14: Magnetic tape installation with EXAKT MES A

1. In this version, the magnetic tape (**M**) is glued to the vertical flat bar guide.
2. First remove the two plastic end caps (**E**) from the magnetic tape → These are required for mechanical protection and must be refitted later.
3. There are already two holes for the end caps in the guide flat bar guide and the correct position of the top edge of the magnetic tape is marked with a scribe mark at the factory (distance to the top edge of the flat bar guide = 18 mm).
4. Before gluing, clean the flat bar guide in the gluing area with a grease-dissolving agent.

5. First push the magnetic tape through the sliding carriage (do not remove the protective film yet).
6. Orientate yourself to the two factory holes in the flat bar guide and the scribe mark (see red line).
7. Then peel off the protective adhesive film a little (slightly longer than the approximate width of the sliding carriage) and stick the magnetic tape only at this point for the time being.
8. Now move the sliding carriage to the position of the magnetic tape that has already been stuck on.
9. Peel off the remaining protective adhesive film, stick on the magnetic tape over the entire length and press on well.
10. Then stick the supplied steel cover tape flush onto the magnetic tape so that it is protected from mechanical influences.
11. Now slide the two plastic end caps (**E**) onto the two magnetic tape ends and fix them in the factory holes with the screws supplied.
12. To enable exact positioning, the position indicator must be referenced with the stop system to the processing machine (for procedure see section ⇒ 8.7).

8.4.2 Magnetic tape installation with EXAKT E/KF



Figure 15: Magnetic tape installation with EXAKT E/KF

1. The magnetic tape (**M**) must be stuck on the inclined mounted guide flat bar guide.
2. First remove the two plastic end caps (**E**) from the magnetic tape → These are required for mechanical protection and must be refitted later.
3. There are already two holes for the end caps in the guide flat bar guide and the correct position of the top edge of the magnetic tape is marked with a scribe mark at the factory (distance to the top edge of the flat bar guide = 12 mm).
4. Then proceed as described in the above section ⇒ 8.4.1 (steps 4. to 12.).

8.5 Connecting the roller conveyor (EXAKT MES A only)

- The electrical connection for the position indicators is established by plugging the safety plug into the corresponding socket.
- The compressed air supply is established by connecting the to a suitable compressed air network. The maximum operating pressure is 6 bar.

8.6 Presetting the stop system (EXAKT MES A only)

8.6.1 Defining the zero point

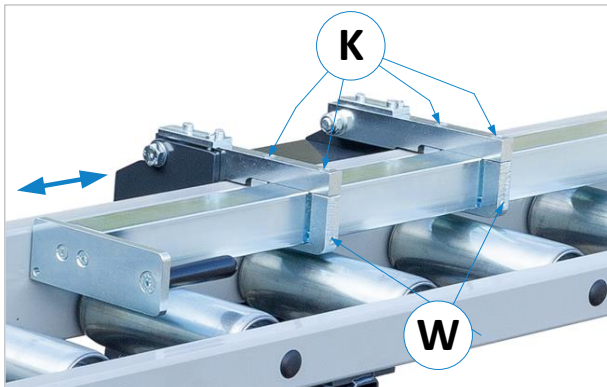

Figure 16: Defining the zero point of the stop system

Before using the stop system, the desired zero point must be defined:

- Loosen the upper 4 clamping screws (**K**).
- Loosen the two lateral grub screws (**W**) only slightly so that the stop arm can be moved.
- Move the stop arm so that the position corresponds to your desired zero point.
- Tighten the two grub screws (**W**) again. Ensure an exact 90° angle (see section ⇒ 8.6.3).
- Tighten the 4 clamping screws (**K**) again moderately (do not overtighten!).

8.6.2 Adjusting the height

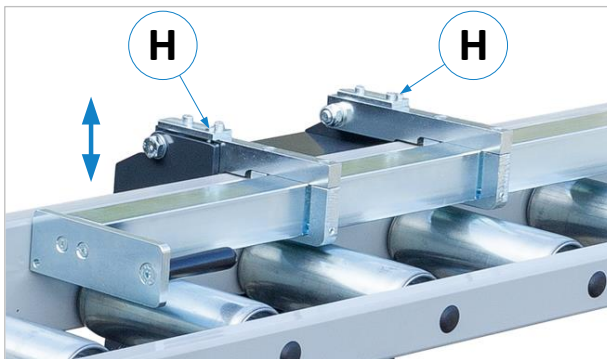

Figure 17: Adjusting the height of the stop system

In some cases it may be necessary to adjust the height of the stop system (distance to the roller conveyor):

- Loosen the lock nuts on the two grub screws (**H**) with an open-end spanner.
- Adjust the desired height with a pin spanner consistently over the two grub screws.
- Ensure parallelism downwards by re-measuring the distance to the roller track on both sides.

8.6.3 Adjusting the 90° angle

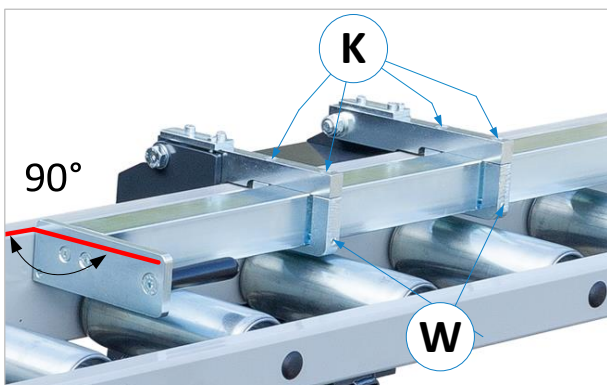

Figure 18: Adjusting the 90° angle of the stop system

Before using the fence, check the 90° angle of the fence to the rear support rail:

- Loosen the upper 4 clamping screws (**K**).
- Adjust the angle to exactly 90° using the grub screws (**W**). Use a suitable tool for this, e.g. protractor or 90° stop angle.
- Tighten the 4 clamping screws (**K**) again moderately (do not tighten too much!).
- Check the 90° angle occasionally and readjust if necessary.

8.7 Referencing the stop system (EXAKT MES A and E/KF only)

The digital position indicators of the stop system must be referenced during commissioning of roller conveyor in relation to the already connected processing machine (e.g. crosscut saw).

Procedure:

- Position the stop of the roller conveyor with the handwheel against the end stop. Beforehand, the fixed stop or the 0-point stop can be pre-adjusted by moving the carriage.
- Then clamp the sliding carriage manually or pneumatically (depending on the model).
- Attach the test piece to the stop, cut to length with the machine and then measure.
- Now compare the dimension of the position indicator with the actually measured dimension of the cut part. If the dimension differs, the actually measured dimension must be stored as a reference value in the position indicator (the corresponding parameter can be found in the respective operating manual).
- Finally, set the position indicator to the stored reference value (calibration).

8.8 Operational readiness of the roller conveyor (EXAKT MES A only)

The roller conveyor is ready for operation after it has been correctly installed and mounted and the electrical and pneumatic connections have been made by suitably qualified personnel.

9 Operating the stop system (EXAKT MES A only)



When adjusting the handwheel, pay attention to existing crushing hazards between moving parts (stop system / workpiece / roller conveyor). Keep hands out of the danger areas!

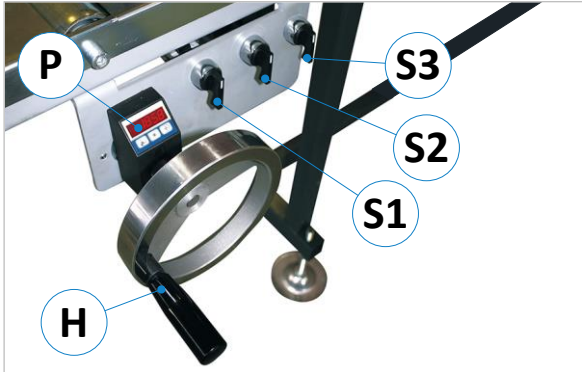

Figure 19: Controls of the stop system

- **Standard:** Adjust the stop to the desired dimension using the handwheel (H) and position indicator (P).
- **Option Z58:** Here the measurement is read from the position indicator mounted at eye level.
- After reaching the set position, hold the handwheel (H) firmly with the left hand and turn the brake switch (S1) to the right with the right hand to clamp the stop in position.

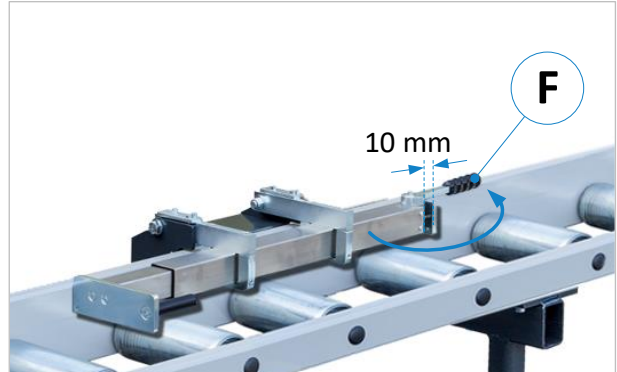

Figure 20: Lever for clearance stroke (option SZ 05)

- **Option SZ 05:** Before starting the cut, create the 10 mm clearance stroke by swivelling the eccentric lever (F) to the rear (see ⇒ Figure 20).
- **Option SZ 07:** The 10 mm clearance stroke is triggered pneumatically → To do this, turn the switch (S2) to the right position.
- **Option SZ 07/1:** The 10 mm clearance stroke is automatically triggered by the processing machine by means of electro-pneumatic control.
- **Standard:** With the handle (G) the stop arm can be folded backwards at any position.
- **Option SZ 08:** Instead of the above-mentioned handle, the stop arm is pneumatically folded upwards by turning the switch (S3) to the right. To fold the stop arm back down to the working position, the switch (S3) must be turned back to the upper starting position.

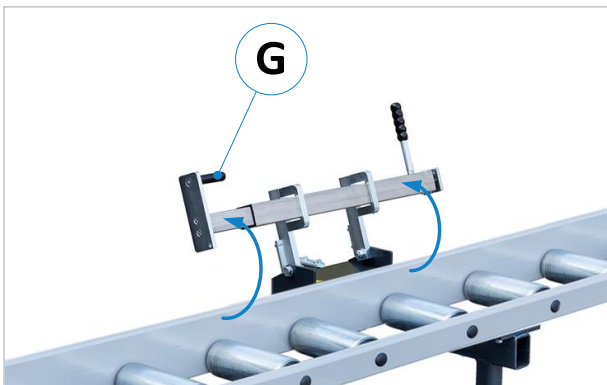

Figure 21: Fold the stop arm backwards



Be aware of the risk of crushing when folding down the stop arm. Hold the stop arm firmly and do not let it fall down. Keep your hands out of the danger zone!

With pneumatically folding stop system (option SZ 08), make sure that no persons are in the danger zone during pneumatic folding down!

10 Troubleshooting



Repair work on electrical, mechanical and pneumatic components may only be carried out by authorised and trained specialist personnel.

Proceed systematically when searching for the cause of a malfunction. If you are unable to find the fault or remedy the malfunction, call our customer service on the telephone no. 0049 7576 / 962 978 - 0.

Before you call us, please follow these steps:



- Keep these operating instructions and any supplementary documents at hand.
- The more precisely you describe the fault to us, the better we can then remedy the situation.

Types EXAKT MES A and EXAKT E/KF only:

Fault	Possible Cause	Remedy
LED position indicator EP6/1 <u>on the handwheel</u> remains dark	No power supply	→ Check cables and connections
	Position indicator is defective	→ Replace or have repaired
	Power supply unit defective	→ Check/replace power supply unit
LED position indicator EP6/1 <u>on the handwheel</u> does not count (no measurement)	No sensor signals	→ Check sensor connections
	Position indicator is defective	→ Replace or have repaired
LED position indicator Z58 (<u>option</u>) remains dark	No power supply	→ Check cables and connections
	Position indicator defective	→ Replace or have repaired
	Power supply unit defective	→ Check/replace power supply unit
LED position indicator Z58 (<u>option</u>) does not count (no measurement) or provides incorrect measurement results	No sensor signals	→ Check sensor connections
	Magnetic sensor defective	→ Replace magnetic sensor
	Distance sensor/band too high	→ Distance must not exceed 5 mm
	Position indicator defective	→ Replace or have repaired
LCD position indicator IZ17E <u>on the sliding carriage</u> remains dark	No power supply	→ Check cables and connections
	Batteries empty or defective	→ Check/replace batteries
LCD position indicator IZ17E <u>on the sliding carriage</u> does not count (no measurement) or provides incorrect measurement results	No signals	→ Check sensor connections
	Magnetic sensor defective	→ Replace magnetic sensor
	Distance sensor/tape too high	→ Distance must not exceed 5 mm
	Magnetic tape defective	→ Replace magnetic tape (⇒ 8.2)
The stop cannot be moved via handwheel	Brake is activated	→ Release brake
	Chain broken	→ Repair or replace chain
	Other reasons	→ Contact customer service
The stop cannot be braked	No compressed air available	→ Connect compressed air
	Brake pads worn	→ Replace brake pads
	Pressure regulator set too low	→ Increase pressure (max. 6 bar)
	Valve defective	→ Replace valve
	Other reasons	→ Contact customer service

11 Maintenance and repair

Maintenance and repair work may only be carried out by competent, trained and instructed personnel. If necessary, further operating instructions and/or additional documents must be observed.

	<i>If maintenance or repair work has been carried out on the roller conveyor, a functional test must be carried out afterwards.</i>
	<i>Maintenance and repair work on electrical, pneumatic and mechanical components may only be carried out by authorised and trained personnel.</i>
	<i>Before carrying out any maintenance or repair work, the chapter ⇒ 4 “Safety” must be read carefully and observed!</i>

- **EXAKT MES A only:** During maintenance and repair work, make sure that the compressed air and power supplies to the roller conveyor are disconnected.
- **EXAKT MES A only:** The sliding carriage guide must be cleaned daily.
- **EXAKT MES A only:** The 90° angle of the stop should be checked occasionally and readjusted if necessary (for procedure see section ⇒ 8.6.3).

Before using the roller conveyor, all electrical cables and compressed air hoses must be checked for damage. Damaged parts must be replaced by qualified personnel due to the risk of accidents! Afterwards, the power and compressed air supplies can be restored.

12 Supplementary documents

	<i>Repair work on electrical resp. electronic components may only be carried out by authorised and trained specialist personnel.</i>
---	---

Please note: If necessary, purchase electronic spare parts exclusively from R. Beck Maschinenbau GmbH. This is the only way to ensure that the correct components are ordered and that compatibility with the roller conveyor is guaranteed.

R. Beck Maschinenbau GmbH excludes all liability and warranty for damage to property and personal injury caused by incorrect or incompatible components.

12.1 EXAKT MES A

The operating manual of the digital handwheel Willtec type **EP6/1** can be found via the following link:

☞ https://beck-maschinenbau.com/wp-content/uploads/BA_BM_EP6-1_DE-EN-FR.pdf

The operating manual for the optional LED position indicator ELGO type **Z58** can be found via the following link:

☞ https://www.elgo.de/fileadmin/user_upload/pdf/manual/indicators/Z58-600-MA-E.pdf

12.2 EXAKT MES E/KF

The short manual for the battery-powered position indicator ELGO type **IZ17E** can be found via the following link:

☞ https://www.elgo.de/fileadmin/user_upload/pdf/manual/indicators/IZ17E-000-SI-DE.pdf

13 Disassembly and scrapping

When dismantling and scrapping the roller conveyor, the current EU regulations or the respective regulations and laws of the country of operation, which are prescribed for proper dismantling and disposal, must be observed. The aim is to dismantle the roller conveyor and its various materials and components properly, to recycle all parts and to dispose of non-recyclable components in the most environmentally friendly way.

	<p>Please pay particular attention to</p> <ul style="list-style-type: none"> • <i>the dismantling of the roller conveyor in the working area</i> • <i>proper dismantling of the roller conveyor and accessories</i> • <i>a safe and proper removal of the roller conveyor</i> • <i>proper separation of all components and materials.</i>
---	--

When dismantling and disposing the roller conveyor, the laws and regulations in force at the place of use concerning health and environmental protection must be observed.

	<p>Remove all residues of oil, grease and other lubricants and have them disposed of properly by a qualified disposal company.</p>
---	---

When separating, disposing of or recycling the roller conveyor materials, comply with the environmental protection laws in force at the place of use regarding the disposal of industrial solid waste toxic and hazardous waste.

	<ul style="list-style-type: none"> • <i>Hoses and plastic parts as well as other components that are not made of metal must be dismantled and recycled or disposed of separately.</i> • <i>Electrical components such as cables, switches, connectors, devices or similar must be extended and (if possible) recycled or otherwise disposed of in a qualified manner.</i> • <i>Pneumatic parts such as valves, pressure regulators, hoses or similar must be dismantled and (if possible) recycled or otherwise disposed of in a qualified manner.</i> • <i>Dismantle the base frame and all metal parts of the roller conveyor and sort them according to material type. Metals can be melted down and recycled.</i>
--	---

In the event of improper disposal of lubricants, the following residual risks to the environment and health exist:

	<p>Pollution of the environment by seepage into groundwater or sewage system.</p>
---	--

	<p>Poisoning of the personnel contracted for the disposal.</p>
---	---

Note: The disposal of lubricants considered toxic and hazardous must be carried out in accordance with the regulations and laws in force at the respective place of use. Only qualified disposal companies that have the appropriate permits for the disposal of used oil and lubricants are to be commissioned with the disposal.

14 Machine card

Company		
Branch		
Street		
Country / postcode / city		
Phone		
Model	EXAKT MES A, C, B/KF, E/KF	
Additional remark		
Manufacturer	Reinhold Beck Maschinenbau GmbH, Im Grund 23, DE 72505 Krauchenwies	
Working range	by type	mm (L x W)
Pressure range	max. 6	bar
Control	pneum.	
Connection	230 / 50	V / Hz
Connected load	max. 10	W
Length	by type	mm
Depth	by type	mm
Height	by type	mm
Weight	by type	kg
Extras		
Paintwork	Anthracite RAL 7016, traffic grey RAL 7042	
Machine number		
Year of manufacture		

15 Options and accessories

	<i>Only use original accessories and spare parts specified by the manufacturer. The use of other accessories or spare parts may cause injury to persons and damage to the roller conveyor. In case of any use of non-prescribed accessories and spare parts or of additional components of third parties, the manufacturer does not assume any liability for resulting damages!</i>
---	---

15.1 Accessories for all EXAKT MES versions

Article	Description	Art. No.
Cover plate	between the carrying rollers, galvanised.	SZ 06
Special working height via adjustable feet	Roller conveyor height deviating from standard construction height 880 ± 60 mm; per roller conveyor foot (for all EXAKT MES models).	SZ 27
Special working height via spindle	Foot plate with spindle M16 x 250 mm long.	SZ 28
Material support arm	extendable, 250 mm long	SZ 35

15.2 Accessories for EXAKT MES A

Article	Description	Art. No.
Stop arm spring loaded, fixed	Fixed spring-loaded stop arm, can be folded back manually.	SZ 04
Stop arm spring loaded to zero	Stop arm spring-loaded and adjustable to zero point and manually foldable backwards.	SZ 05
Pneumatic stop arm retraction	10 mm clearance stroke from the spring-loaded stop arm (SZ 05).	SZ 07
Electropneumatic stop arm retraction	Electropneumatic arm retraction (clearance stroke 10 mm) from the stop. Controlled via the start/stop function of the saw. The signals from the saw motor control the stop system. With the "motor start" switch, the stop moves back, with the "motor stop" switch, the stop moves forward again to its dimension with a time delay (adjustable). The automatic arm retraction can be switched on/off manually. The control unit is completely installed in a switch cabinet, incl. cable for the electrical connection to the start relay of the saw. The electrical installation must be carried out by a qualified electrician.	SZ 07/1
Pneumatic folding stop arm	Stop arm can be folded back pneumatically.	SZ 08
Measuring system Z58	Magnetic measuring and indicating system with 1/10 mm indicator Z58, magnetic pole ring and sensor head.	SZ 09
Z 58 + magnetic tape 2 - 8 m	The EXAKT MES A roller conveyors can also be supplied with a linear magnetic tape measuring system incl. Z58 indicator.	2 m SZ 10 3 m SZ 11 4 m SZ 12 5 m SZ 13 6 m SZ 14 7 m SZ 15 8 m SZ 16
Stop extension bolt	300 mm long	SZ 26
Stop extension	250 mm long	SZ 34

Installation declaration for the component (as an incomplete machine)

in accordance with the EU Machinery Directive 2006/42/EC Annex II A

The manufacturer,

Fa. Reinhold Beck
Maschinenbau GmbH
Im Grund 23
DE-72505 Krauchenwies (Germany)
Phone: 0049 - 7576 962 978 0
Fax: 0049 - 7576 962 978 90

hereby declares that the manufactured machine

Models: **EXAKT MES A, C, B/KF, E/KF**
Type designation: Roller conveyor / Roller and measuring conveyor
Serial number(s):
Year of manufacture:

in the version provided complies with the EU Machinery Directive 2006/42/EC and the following further directives.

The following harmonised standards and instructions have been applied in manufacturing the machine:

EN ISO 12100:2010 Safety of machinery - General principles for design -
Risk assessment and risk reduction

Important note: The supplied component (as an incomplete machine) must not be put into operation until the complete machine into which it is to be installed is in conformity with the Machinery Directive.

Name: Beck
First name: Reinhold
Position: Managing Director

Krauchenwies, 12.09.2023

Place and date



Signature