

TRANSLATION OF THE ORIGINAL VERSION

CE



Operating Manual

Height-adjustable Work and Assembly Benches

Supporter AM 500 FH and AM 1200 FH

Supporter AM 400 ESA and AM 500 ESA



Valid for Supporter types:

**AM 500 FH and AM 1200 FH
AM 400 ESA and AM 500 ESA**

Reinhold Beck Maschinenbau GmbH

Im Grund 23 | DE -72505 Krauchenwies

Tel.: +49 (0) 7576 / 962 978 - 0 | Fax: +49 (0) 7576 / 962 978 - 90

E-Mail: info@beck-maschinenbau.de | Web: <https://www.beck-maschinenbau.de>

Table of Contents

1	Introduction.....	4
1.1	Legal Notice.....	4
1.2	Illustrations.....	4
2	Symbols.....	4
2.1	General Symbols.....	4
2.2	Symbols in Safety Instructions.....	5
3	General.....	6
3.1	Advantages.....	6
3.2	Applications.....	6
3.3	Target Group and Previous Experience.....	6
3.4	Requirements for the Operators.....	6
3.5	Accident Prevention.....	7
3.6	General Safety Regulations.....	7
3.7	Standard Equipment.....	7
3.8	Options and Accessories.....	7
4	Safety.....	8
4.1	Basic Safety Instructions.....	8
4.2	Application Area and Intended Use.....	8
4.3	Improper Use.....	8
4.4	Consequences in Case of Disregard.....	9
4.5	Conversions and Modifications of Supporter.....	9
4.6	Load Distribution and Influence on the Nominal Load.....	9
4.7	Hazardous Areas.....	10
4.8	Residual Risks.....	11
4.9	Observe the Environmental Protection Regulations.....	11
4.10	Organisational Measures.....	12
4.11	Personnel Selection and Qualification - Basic Duties.....	12
5	Technical Specifications.....	13
5.1	Manufacturer and Nameplate.....	13
6	Transport to the Installation Site.....	14
6.1	Unloading the Supporter.....	14
6.2	Requirements for the Installation Site.....	15
6.3	Temporary Storage.....	15
6.3.1	Short Term Storage.....	15
6.3.2	Long Term Storage.....	15
6.4	Lashing on a Transport Vehicle.....	15
7	Components and Controls.....	16
7.1	Basic Equipment AM 500 FH & AM 1200 FH.....	16
7.2	Basic Equipment AM 400 ESA & AM 500 ESA.....	17
8	Installation and Commissioning.....	18
9	Operation.....	18
9.1	Loading and Unloading the Platform.....	18
9.2	Lifting and Lowering the Platform.....	18
		2

9.3	Moving the Supporter via Swivel Castors	18
9.4	Height Adjustment	19
9.4.1	AM 500 FH / AM 1200 FH	19
9.4.2	AM 400 ESA / AM 500 ESA	19
10	Vacuum Clamping Unit (Option).....	20
10.1	Switching on the Vacuum Pump.....	20
10.2	Clamping a Workpiece	21
10.2.1	Clamping the Workpiece with Vacuum Suction Cups	21
10.2.2	Clamping a Workpiece with the Universal Clamping Plate	21
10.3	Unclamp Workpiece.....	22
10.3.1	Technical Specifications of the Vacuum Pump	22
11	Troubleshooting	23
12	Maintenance and Repair	24
12.1	Maintenance Intervals	24
13	Decommissioning	24
14	Disassembly and Scrapping	25
15	Options and Accessories.....	26
15.1	Table Tops, Shelves, Supports etc.	26
15.2	Vacuum Clamping Unit.....	28
15.3	Drawers, Tool Cabinets and other Accessories.....	29
15.4	AM 500 FLEXX FH and AM 1200 FLEXX FH	30
15.4.1	Table Tops for AM 500 - 1200 FLEXX FH	31
	EU - Declaration of Conformity.....	32

List of Figures

Figure 1: Permissible load with load distribution	9
Figure 2: Nameplate	13
Figure 3: Transport to installation site	14
Figure 4: Basic equipment AM 500 FH & AM 1200 FH	16
Figure 5: Basic equipment AM 400 ESA & AM 500 ESA.....	17
Figure 6: Foot pedal for height.....	19
Figure 7: Control panel with buttons	19
Figure 8: Vacuum clamping unit	20
Figure 9: Vacuum suction cups	20
Figure 10: Universal clamping plates	20
Figure 11: Vacuum main switch	20
Figure 12: Suction cup valve	21
Figure 13: Quick release coupling	21
Figure 14: Rubber sealing strip	21
Figure 15: Place workpiece	21
Figure 16: Machining workpiece	21
Figure 17: Swivel clamping plate.....	22
Figure 18: Foot switch for unclamping the workpiece	22
Figure 19: Remove workpiece.....	22
Figure 20: AM 500 -1200 FLEXX FH	30

Revisions:

Revision	Autor	Modification	Date
001	AG	Original manual translated	17-11-2021

1 Introduction

The information in this operating manual enables safe, proper and economical operation of your work and assembly bench. Please observe all the explanations, notes and regulations

- to avoid dangers and malfunctions,
- to reduce repair costs and downtimes
- and to increase reliability and service life

of your work and assembly bench.

The operating manual must be read and used by each person entrusted with carrying out work with the work and assembly bench. This must be ensured by the operator. Further this manual as well as any appendices and additional documents must be kept easily accessible at the place of use of the work and assembly bench.

	<p><i>Ignorance or non-observance of these operating instructions may result in certain accident hazards during <u>handling</u> with the work and assembly bench. Before commissioning, this operating manual and any appendices and additional documents must be read thoroughly. All instructions, in particular the safety regulations, must be observed!</i></p> <p><i><u>Handling</u> the supporter in the sense of these instructions means</i></p> <ul style="list-style-type: none"> • <i>the installation and commissioning,</i> • <i>the operation and proper usage,</i> • <i>the influence on operating conditions, as well as</i> • <i>the maintenance, troubleshooting and repair.</i>
---	---

Apart from the operating manual and the legally binding accident prevention provisions applicable in the country and place of use, the recognized technical regulations for safe and proper work must also be observed.

1.1 Legal Notice



All contents of these operating instructions are subject to the rights of use and copyright of Reinhold Beck Maschinenbau GmbH. Any reproduction, modification, further use and publication in other electronic or printed media, as well as their online publication, requires the prior written consent of Reinhold Beck Maschinenbau GmbH.

1.2 Illustrations

All photos, figures and graphics contained in this document are for illustration and better understanding only and may differ from the current state of the product.

2 Symbols

2.1 General Symbols

Symbol	Meaning
	Indicates passages within this operating manual that must be particularly observed in order to prevent malfunctions or damage to the work and assembly bench.
	Refers to chapters, sections, or figures within this document.
	Refers to an external document or a third-party source.

2.2 Symbols in Safety Instructions

The supporter is designed and manufactured according to the current state of the art. Nevertheless, residual hazards may occur during handling. In this operating manual, possible dangers and residual risks are pointed out at appropriate places.

Safety instructions are provided with corresponding danger symbols which have the following meanings:

Symbol	Safety Instruction
	Reading and applying the operating manual is mandatory for the operating personnel. <i>Failure to abide by the following precautions could lead to serious or possibly fatal injury.</i>
	General danger symbol, which requires the highest attention! <i>Failure to observe may result in damage to the equipment, serious injury or even death.</i>
	This symbol warns of the dangers of electric voltage! <i>Failure to observe may result in damage to the equipment, serious injury or even death.</i>
	Reference to a prohibited zone under a lifted load! <i>Do not enter! There is an increased risk of injury or even death.</i>
	Reference to a prohibited zone on a platform! <i>Do not enter! There is an increased risk of injury or even death.</i>
	Reference to a possible crushing hazard! <i>Non-observance increases the risk of injury to hands and fingers!</i>
	Reference to a possible crushing hazard! <i>Non-observance increases the risk of injury to feet and toes!</i>
	Possible dangerous crushing hazard in the area of stationary objects! <i>Risk of personal injury and possibly additional equipment damage.</i>
	Reference to a possible hazard due to forklift traffic! <i>Non-observance can result in life-threatening injuries.</i>
	Reference to a possible danger under suspended loads! <i>Non-observance can result in life-threatening injuries.</i>
	Reference to possible tripping and slipping hazards on the floor! <i>Non-observance may result in minor or severe injuries.</i>
	Reference to possible environmental pollution! <i>Non-observance poses a risk of pollution of the environment and groundwater!</i>
	Reference to the obligation to wear safety shoes resp. protective gloves! <i>Non-observance may result in increased risk of injury to feet & toes or hands & fingers!</i>
	Fire hazard! Do not smoke and do not ignite open fire.
	Access for unauthorized persons prohibited! <i>Risk of personal injury and possibly additional equipment damage.</i>

3 General



The operating manual must be read carefully and understood before handling the work and assembly bench! If anything is unclear, please contact the manufacturer.

The AM supporter series was specially developed for manual workstations in manufacturing, assembly and maintenance. The various models already cover a wide range of applications. In addition, a comprehensive range of accessories allows for even better adaptation to different applications.

3.1 Advantages

- Back-friendly height adjustment, either foot-hydraulically (FH series) or via electric spindle adjustment (ESA series)
- Uniform adjustment to height even under uneven load distribution
- The side walls provide stability and protect the mechanics
- High quality hydraulic system or linear drive units
- Table top moves absolutely parallel and smoothly
- 4 stable and robust swivel castors with 2 brakes

3.2 Applications

Supporters of the AM series can be used for all work corresponding to its intended use in section ⇒ 4. The supporter is suitable for use as work equipment for transporting, lifting and lowering loads and also as a height-adjustable assembly table. Typical areas of application are workplaces in manufacturing, assembly and maintenance, where precise height adjustment for ergonomic working as well as high flexibility and mobility are of particular importance.

The supporter must not be used for work that does not correspond to its intended use (see section ⇒ 4).

3.3 Target Group and Previous Experience

This operating manual is intended for the operating and maintenance personnel of the work and assembly bench. The operating personnel is to be determined by the operator and must further meet the following requirements:

- Basic technical and mechanical knowledge as well as knowledge of the associated technical terms
- Reading and understanding these operating and maintenance instructions

In order to acquire the knowledge required to operate this work and assembly bench, the operator must ensure the following measures:

- Product training for every operator (also possible external personnel)
- Regular safety instruction

3.4 Requirements for the Operators

- ⚠ The operator is responsible for the safe use of the work and assembly bench!
- ⚠ The supporter may only be operated by trained personnel who have also read this manual.
- ⚠ Inspection, maintenance, cleaning and repair may only be performed by technical specialists with product-specific training and mechanical and/or electrical training.
- ⚠ Specialists with product-specific training are to be commissioned and held responsible for planning and checking the work.
- ⚠ The national protective regulations for employees must be observed
- ⚠ The legal minimum age must be observed.

3.5 Accident Prevention

To avoid accidents, the following rules must be observed for operation:

- ⚠ Prevent unauthorized persons from gaining access to the work and assembly bench.
- ⚠ Keep unauthorized persons away from the danger areas.
- ⚠ Repeatedly inform present other persons about existing residual risks (see section ⇒ 4.8).
- ⚠ Conduct and record regular training & instruction for persons who must be in the area of the work and assembly bench.
- ⚠ New employees must be trained internally to work on a supporter and this training must be documented.
- ⚠ It is not permitted to enter the supporter platform or to transport resp. lift persons.

3.6 General Safety Regulations

In general, the following safety regulations and obligations apply when handling the work and assembly table:

- ⚠ The supporter may only be operated when it is in perfect working order.
- ⚠ It is prohibited to remove, modify or bypass any protective, safety or monitoring equipment.
- ⚠ It is forbidden to modify or alter the supporter without the written approval of the manufacturer / supplier.
- ⚠ Faults or damage must be reported to the operator immediately, eliminated without delay and repaired if necessary.
- ⚠ Repair and maintenance work on electric, hydraulic, and pneumatic components (e.g. electric drives, hydraulic cylinders, vacuum pumps, etc.) may only be performed by authorized and trained personnel.
- ⚠ Maintenance must be carried out and documented in accordance with the maintenance instructions.
- ⚠ For repairs, only original spare parts from the manufacturer may be used.
- ⚠ Only instructed, trained or qualified persons may work on the work and assembly bench.
- ⚠ For the operation of the work and assembly bench, the respective national safety regulations for employees as well as the national safety and accident prevention regulations apply.

3.7 Standard Equipment

- Without table top and shelf (bottom) as standard.
- Uniform height adjustment even with uneven load distribution or eccentric loading.
- The AM 500 FH and AM 1200 FH models are steplessly foot-hydraulically height-adjustable (via a foot pedal mounted on the left side with separate pedal surfaces for up/down).
- The AM 400 ESA and AM 500 ESA models are infinitely height-adjustable (electrically via spindle motor, by two synchronous actuator drives with control board and push buttons for up/down).
- Additional space under the worktop (e.g. for optional shelf and lower tool cabinet).
- 4 swivel castors (Ø 125 mm), 2 with brake
- CE-compliant version

3.8 Options and Accessories

- Special accessories and optional components can be found in chapter ⇒ 15.

4 Safety

4.1 Basic Safety Instructions

Work and assembly benches can be dangerous if used improperly. Therefore, observe the safety instructions listed in this chapter and the accident prevention regulations of your employer's liability insurance association!



The manufacturer accepts no liability for damage and malfunctions resulting from failure to observe these operating instructions.

4.2 Application Area and Intended Use

The hydraulically adjustable supporters of the AM series conform to the Machinery Directive 2006/42/EC and are therefore suitable as technical equipment for both industrial and commercial applications as well as for training purposes in educational institutions.



Improper use can lead to danger to persons and to a defect or damage to the supporter

- ⚠ The supporter is primarily intended for operation in covered indoor areas, but it can also be used outdoors for loading and unloading purposes (e.g. from the service vehicle to the place of use).
- ⚠ Work on the supporter may only be performed at sufficiently illuminated workplaces.
- ⚠ The supporter is intended for processing, equipping, assembling and transporting assemblies, workpieces and similar components as well as for lifting, lowering and moving loads.
- ⚠ The supporter may only be used on horizontal floors for lifting loads.
- ⚠ The supporter may only be moved when the load is lowered.
- ⚠ The supporter must be positioned freely in the room when lifting and lowering. This means that no shearing or crushing edges may be caused by the movement of the work and assembly bench.
- ⚠ The maximum load (see ⇒ 5 "Technical Specifications") with load center in the middle of the supporter must not be exceeded. If the supporter is loaded unevenly, outside the load center of gravity, the load capacity is of the maximum permitted load capacity (see ⇒ Figure 1).
- ⚠ The supporter is not intended for moving and transporting persons.
- ⚠ The supporter must not be operated in potentially explosive working areas. Any other use is considered improper and prohibited.

4.3 Improper Use

Improper use is when the supporter is used for purposes other than those prescribed in this operating manual and in section ⇒ 4, for example

- ⚠ Use and application for private or non-commercial purposes,
- ⚠ Use in disregard of the regulations in the operating manual,
- ⚠ use after unauthorized conversions or modifications,
- ⚠ Exceeding the maximum permissible load (see ⇒ 5 "Technical Specifications")
- ⚠ Transporting or conveying persons with the work and assembly bench
- ⚠ Entering the work and assembly bench

In case of improper use of the work and assembly bench, any warranty, liability and other claims for damages of the operator against the manufacturer are excluded!

4.4 Consequences in Case of Disregard

If the supporter is not operated, maintained or repaired in accordance with the safety regulations, not as intended, improperly or in an abusive manner, the following will result:

- ⚠ Dangers to the health of the operating personnel
- ⚠ Dangers to the supporter and objects in its vicinity
- ⚠ Impairment of the supporter function

In case of improper use of the work and assembly bench, any warranty, liability and other claims for damages of the operator against the manufacturer are excluded!

4.5 Conversions and Modifications of Supporter

- ⚠ Only use the supporter in its original condition, i.e. as delivered!
- ⚠ The components of the supporter must not be changed in their type and condition.
- ⚠ Only original spare parts and accessories from the manufacturer (see ⇨ 15) may be used.
- ⚠ Deviations are not permitted.

	<p><i>Unauthorized modifications or conversions by the operator, without the written consent of the manufacturer, are prohibited. This excludes any warranty, liability and other claims for damages by the operator against the manufacturer!</i></p>
---	---

4.6 Load Distribution and Influence on the Nominal Load

The nominal, maximum permissible load of supporter is based on a load evenly distributed on the platform. If the load cannot be distributed evenly on the platform, the maximum permissible load must be reduced according to the figures below.

Figure 1: Permissible load with load distribution

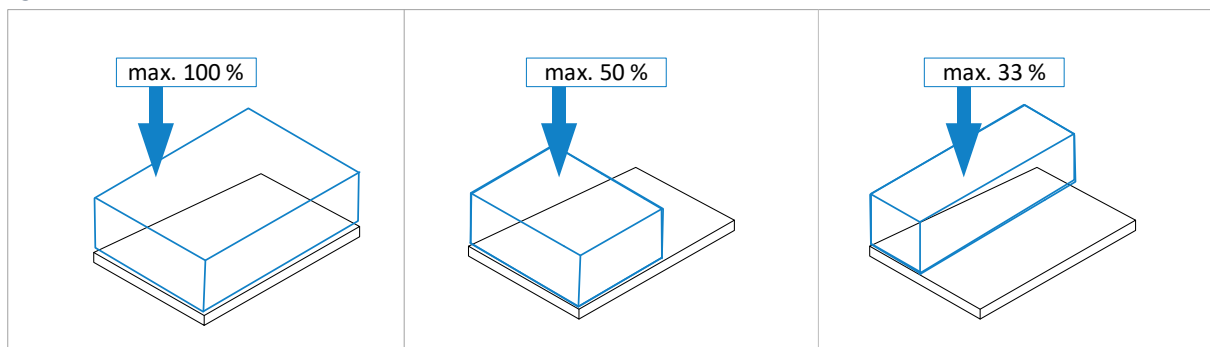

Even distribution

Load is evenly distributed over the entire platform area
 → 100 % of the nominal load is permissible.

Uneven distribution

Load is distributed over half of the platform in transverse direction
 → 50 % of the nominal load is permissible.

Uneven distribution















Load is distributed over half of the platform in longitudinal direction
 → 33 % of the nominal load is permissible.

4.7 Hazardous Areas

Source	Area	Cause	Risk	Prevention
Foot pump 	On the foot pedal for height adjustment	Slipping off the foot pedal	Injuries to feet and legs	Keep foot pedal and shoes dry Wear work shoes with non-slip soles
Mechanics 	Under the table top	Crushing and shearing points	Loss of limbs, crushing of hands, increased risk of injury and even death	Do not reach under the table top during operation and do not move your body into this area
Hydraulic system 	On hydraulic cylinders and all oil-bearing parts, seals and lines	Oil spraying out with high pressure in case of damaged cylinder or seals	Injuries and poisoning of the eyes	Wear safety goggles or face shield Repair damaged parts and/or seals immediately (only qualified personnel!)
Pneumatics 	Rear openings of the Vacuum pump	Outflowing air, gases and dust	Injuries of the eyes	Do not look into the openings, wear safety goggles or face shield
Electrics 	At the mains connection and at the motor control unit as well as at all intervening current-carrying parts and cables	Electrical voltage (230 VAC)	Electric shocks with increased risk of injury up to death	Avoid moisture Have defective parts / insulation repaired immediately (only qualified personnel!) Do not touch energised components

4.8 Residual Risks

The supporter is built according to the latest state of the art and the recognised safety rules. Nevertheless, the use of the supporter may cause danger to life and limb of the user or third parties or damage to the supporter and other equipment. Due to the construction of the supporter, the following residual risks can occur even when used as intended and despite compliance with all relevant safety regulations:

	Reading and applying the operating manual is mandatory for the operating personnel.
	Be alert to possible crushing hazards: a) when transporting the supporter by forklift truck: between forks & pallet / supporter b) when picking up the supporter: between supporter / pallet and floor c) when lowering the supporter: between supporter and fixed equipment
	Be alert to possible crushing hazards when lowering the supporter (from the cargo pallet to the floor) with a forklift truck or overhead crane.
	Be aware of the danger from falling objects such as workpieces, tools or similar. Therefore, wear safety shoes, especially when transporting and setting down the supporter.
	It is strictly forbidden to "ride along" with the supporter during a lifting operation (by means of a forklift truck or overhead crane). There is a high risk of falling!
	It is strictly forbidden to enter or climb onto the supporter during a lifting operation (by means of a forklift truck or overhead crane). There is a high risk of falling!
	Increased risk of injury or even death. Entering the danger zone under a lifted load during transport or installation by means of a forklift truck is prohibited!
	Increased risk of injury or even death. It is forbidden to enter the forklift platform during transport or installation!
	Unauthorised persons are not allowed to enter the supporter installation area (responsibility of the operator).
	Danger of electric shock on models with battery-operated hydraulic height adjustment! Work on the electrical components may only be carried out by qualified personnel.
	Be aware of possible tripping and slipping hazards on the floor. Prevent possible hazards by keeping the floor dry and clean and by using anti-slip floor coverings around the supporter.
	Acute danger of crushing underneath the table top! Never reach into the shears and never move your body into this area! There is an increased risk of accidents with loss of limbs or even death.
	When using additional machines on the supporter, first read the respective operating instructions and comply with the specified safety regulations.
	Be aware of the fire hazard during the processing of wood due to wood dust, in connection with flying sparks and/or open fire!
	Danger of electric shock on models with battery-operated hydraulic height adjustment! Work on the electrical components may only be carried out by qualified personnel.

4.9 Observe the Environmental Protection Regulations

During all work with the supporter, the environmental protection regulations, obligations and laws for waste avoidance and proper recycling and/or disposal applicable at the place of use must be observed. This applies in particular to installation, repair and maintenance work involving substances that could pollute the groundwater (e.g. hydraulic oils and cleaning agents and liquids containing solvents). In any case, prevent them from seeping into the ground or entering the sewage system.

	Store and transport the above-mentioned hazardous substances only in suitable containers. Avoid leakage of hazardous substances by using suitable collection containers. Ensure that the above-mentioned substances are disposed of by a qualified disposal company.
---	---

4.10 Organisational Measures

- ⚠ Always keep this operating manual within easy reach and at the place of use of the supporter.
- ⚠ In addition to the operating manual, observe and instruct on generally applicable legal and other binding regulations for accident prevention and environmental protection.
- ⚠ Supplement the operating manual with further instructions, including supervisory and reporting duties, to take account of special operational features (e.g. with regard to work organisation, work processes, personnel employed).
- ⚠ Before starting work on the supporter, the person responsible for its operation must have read the operating instructions, especially the chapter "Safety Instructions". This applies in particular to personnel who only occasionally work on the supporter.
- ⚠ Check that work is carried out in a safety-conscious and hazard-conscious manner and in compliance with the operating manual.
- ⚠ When using additional machines on the supporter, read the respective operating instructions and keep them handy. Pay particular attention to the respective safety and hazard information.
- ⚠ In case of safety-relevant changes to the supporter or its operating behaviour, shut down the entire system immediately and report the fault to the responsible office/person.
- ⚠ Use personal protective equipment as necessary or required by regulations.
- ⚠ Do not make any modifications, additional attachments or conversions to the supporter without the manufacturer's approval! This will compromise safety and invalidate the manufacturer's warranty and any liability claim.
- ⚠ Spare parts must meet the technical requirements specified by the manufacturer. The exclusive use of original spare parts ensures this. Therefore, only use original spare parts from the manufacturer.
- ⚠ Observe the fire alarm and firefighting possibilities. Make the location and operation of fire extinguishers (fire class ABC) known. Do not use water!

4.11 Personnel Selection and Qualification - Basic Duties

- ⚠ The design and operation of the supporter is equally suitable for right- and left-handers.
- ⚠ The supporter is designed to be operated by a single person. Other persons in the vicinity of the supporter must keep a suitable safety distance.
- ⚠ Work on and with the supporter may only be carried out by reliable personnel.
Observe the legal minimum age!
- ⚠ Only use trained or instructed personnel. Clearly define the responsibilities of the personnel for operating, setting up, maintaining and repairing!
- ⚠ Ensure that only authorised personnel work on the supporter!
- ⚠ If personnel to be trained or apprenticed have to work on the supporter, this may only be done under the constant supervision of an experienced resp. qualified person.
- ⚠ Work on hydraulic equipment may only be carried out by authorised and trained personnel.
- ⚠ Work on the electrical equipment of the supporter may only be carried out by a qualified electrician or by instructed persons under the direction and supervision of a qualified electrician in accordance with the electrotechnical regulations.

5 Technical Specifications

Version Article number	AM 500 FH 210.100.00	AM1200 FH 210.200.00	AM 400 ESA 212.300.00	AM500 ESA 212.310.00
Platform size ¹	1460 x 740 mm	1460 x 740 mm	1460 x 740 mm	1460 x 740 mm
Total height	970 mm	970 mm	970 mm	970 mm
Supporter height	670 mm	670 mm	670 mm	670 mm
Effective stroke	300 mm	300 mm	300 mm	300 mm
Lifting speed	manually	manually	approx. 6 mm/s	approx. 10 mm/s
Clear width (columns)	1105 mm	1105 mm	1105 mm	1105 mm
Swivel castors	4 x Ø 125 mm	4 x Ø 125 mm	4 x Ø 125 mm	4 x Ø 125 mm
Number of brakes	2	2	2	2
Height adjustment	hydraulically	hydraulically	spindle motor	spindle motor
Control elements	foot pedal	foot pedal	push-buttons	push-buttons
Load capacity	max. 500 kg	max. 1200 kg	max. 400 kg	max. 500 kg
Net weight ²	approx. 120 kg	approx. 150 kg	approx. 135 kg	approx. 140 kg
Hydraulic power units	1 x left	1 x left / 1 x right	none	none
Electric drives	none	none	1 x left / 1 x right	1 x left / 1 x right
Connection voltage	none	none	230 VAC / 50 Hz	230 VAC / 50 Hz
Type of connection	none	none	earthed connector	earthed connector

5.1 Manufacturer and Nameplate

Manufacturer:

Reinhold Beck Maschinenbau GmbH
Im Grund 23
DE-72505 Krauchenwies (Germany)
Phone: +49 (0) 7576 / 962 978 - 0
Fax: +49 (0) 7576 / 962 978 - 90
Email: info@beck-maschinenbau.de

Nameplate:

The nameplate provides information about the characteristic values of your supporter:

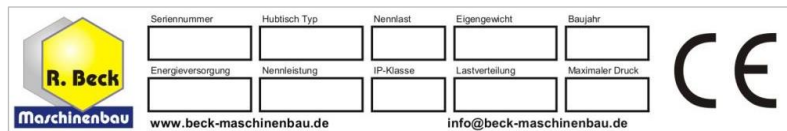

Figure 2: Nameplate

Note: Before using the unit in a way that deviates from the described suitability (see section ⇨ 4), it is essential to consult the manufacturer. Otherwise all warranty, liability and other claims for damages of the operator against the manufacturer will be voided!

¹ Platform size does not include optional table top, which is available as an accessory.







² The net weight refers to the basic equipment without table top and other accessories.

6 Transport to the Installation Site

Only trained personnel may be used for the following work:

- Unloading the supporter
- Check delivery condition of the supporter
- Transport the supporter

6.1 Unloading the Supporter

	<i>There is an increased risk of accidents when unloading and transporting the supporter! The supporter can fall or tip over due to its weight!</i>
	<i>Use only suitable and technically perfect lifting gear and suspension systems with an adequate lifting capacity of 500 kg. Only transport the supporter on level, solid ground!</i>
	<i>When placing the supporter, pay attention to the possible danger of crushing in the area of stationary objects around the supporter!</i>
	<i>Warning: Increased risk of injury and death! Never stand under the load when lifting and putting it down! Instruct bystanders to leave the danger zone!</i>
	<i>Warning: Increased risk of injury and death! Do not enter or climb onto the forklift platform during transport!</i>
	<i>Increased risk of crushing feet and toes! Wear steel-toed safety shoes!</i>

Unloading by forklift truck

- With the forks set appropriately, drive centrally into the designated places on the freight pallet on the longitudinal side of the supporter and lift carefully.
- Carefully lift the supporter from the truck. The net weight is approx. 120 kg (AM 500 FH), approx. 150 kg (AM 1200 FH), approx. 135 kg (AM 400 ESA) and approx. 140 kg (AM 500 ESA), each without accessories.

Check delivery condition

- Check for completeness and transport damage. In case of transport damage or missing parts, document these immediately on the consignment note of the transport company. At the same time, inform the manufacturer of the situation.

Transport to the installation site

- Transport the supporter to the installation site with a forklift truck or pallet truck, in accordance with the general safety regulations.

Unpacking and placing

- Unpack the supporter and remove the packing material. Then lift the supporter from the transport pallet with a forklift. When doing so, drive under the centre of the long side of the supporter with appropriately adjusted forks (see ⇨ Figure 3). Then lift carefully from the pallet, remove the pallet and set the supporter down on the ground.

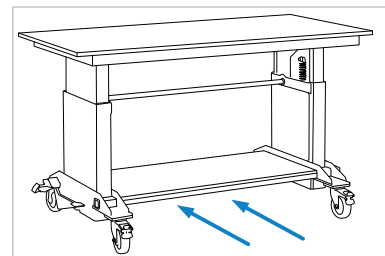



Figure 3: Transport to installation site

	<i>Dispose of the packaging material in an environmentally friendly manner!</i>
	<i>Fire hazard! Do not smoke or light an open fire</i>

6.2 Requirements for the Installation Site

The following guidelines apply with regard to space requirements, load-bearing capacity and the condition of the substrate:

- Space requirements: B x H x T = 1600 x 700 x 800 mm (with table top)
- Load capacity: Concrete of classification B 15
- Conditions: Level, smooth, non-slip and tilt-free

6.3 Temporary Storage

If the supporter is not put into operation immediately after delivery, it must be stored carefully in a protected place. Carefully cover the entire supporter so that neither dust nor moisture can penetrate.

6.3.1 Short Term Storage

- Dry environment
- Protect components at risk of corrosion
- Park in a stable place

6.3.2 Long Term Storage

- Dry environment
- Protect components at risk of corrosion
- Protect supporter from dirt
- Park in a stable place

6.4 Lashing on a Transport Vehicle

The supporter must be lashed to the loading area of the transport vehicle on a transport pallet for possible onward transport. For this purpose, at least two lashing straps with the appropriate load-bearing capacity must be used.

The responsibility for safe loading is borne by the respective shipper!

	<i>A separate lashing strap must be used for each lashing and must be tensioned individually on the floor of the loading area of the vehicle! The pallet must also be secured against slipping.</i>
---	--

Please note the following when lashing in the transport vehicle:

- The supporter must be secured on the pallet with the two parking brakes and, if necessary, other measures (wedges etc.) to prevent it from rolling away.
- The loading area of the transport vehicle must always be clean and dry.
- The lashing straps used must be suitable for the total weight of the supporter (see chapter ⇨ 5).
- Fastening on the loading area is done by lashing down: This means that the transport pallet is secured by frictional locking. The load is pressed so firmly onto the loading surface that it can no longer slip. The clamping tool should have a high STF value at the frictional connection, e.g. long-lever ratchets.
- In addition, anti-slip mats should be used to provide even more safety.
- The ideal lashing angle (α) for tie-down lashing is 83° to and 90°. Therefore, the lashing straps should pull downwards approx. vertically. As the angle decreases, the pretensioning force of the lashing is reduced.
- Observe the permissible total weight of the transport vehicle.
- Ensure that the permissible axle loads of the transport vehicle are observed. The load must be distributed evenly on all axles of the vehicle.

7 Components and Controls

7.1 Basic Equipment AM 500 FH & AM 1200 FH

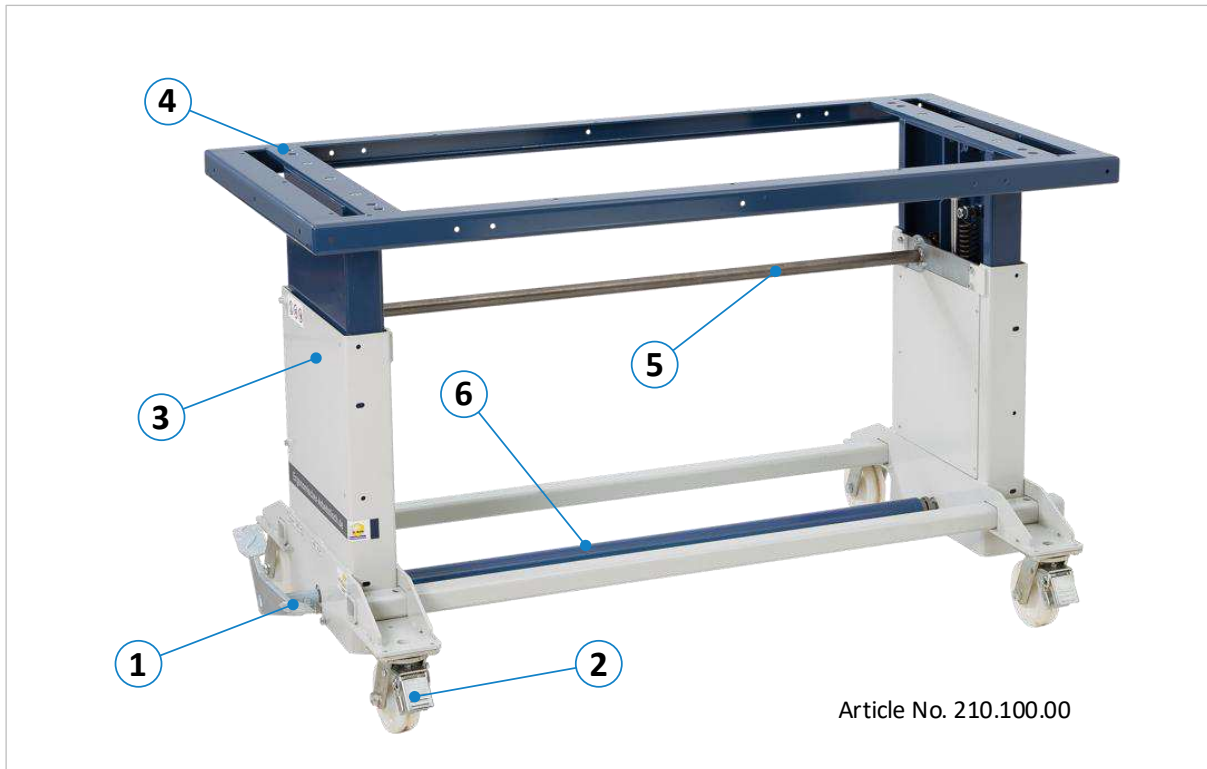

Figure 4: Basic equipment AM 500 FH & AM 1200 FH

Pos.	Description	Pos.	Description
1	Foot pedal for height adjustment	4	Support frame for table top
2	Swivel castors (2 x with brakes on front side)	5	Synchronous shaft (top)
3	Lifting column with hydraulic cylinder	6	Synchronous shaft (bottom)

For available table tops and shelves as well as other accessories, refer to chapter ⇒ 15.

7.2 Basic Equipment AM 400 ESA & AM 500 ESA



Figure 5: Basic equipment AM 400 ESA & AM 500 ESA

Pos.	Description	Pos.	Description
1	Push-button unit for height adjustment ▲/▼	3	Lifting column with spindle motors
2	Swivel castors (2 x with brakes on front side)	4	Support frame for table top

For available table tops and shelves as well as other accessories, refer to chapter ⇒ 15.

8 Installation and Commissioning

The supporter must be set up in a stable position so that there are no crushing or shearing points between the supporter and/or the load and objects in the vicinity. Therefore, ensure sufficient space around the supporter. It must be possible to carry out the intended work on the supporter or the load without obstruction.

The following installation and operating requirements must be observed:

- ⚠ The supporter must be integrated into the existing machinery in such a way that the basic safety requirements of the EU Machinery Directive 2006/42/EC are met. This must be checked and ensured by the operator of the supporter.
- ⚠ The environment must not be explosive.
- ⚠ This operating manual and any supplementary documents must be read carefully and understood. All safety instructions and regulations must be observed and complied.

9 Operation



Before operating the supporter, the operator must ensure that no hazards are caused by the movement of the supporter platform.



Generally wear steel-toed safety shoes and suitable protective work clothing!

9.1 Loading and Unloading the Platform

- 👉 When loading or unloading the work platform, the load distribution according to section ⇒ 4.6 “Load Distribution and Influence on the Nominal Load“ must be observed and complied with.
- 👉 A load placed on the supporter must be secured with suitable measures against slipping, tipping over, rolling away and falling down. This is particularly necessary for loads that have an unstable position on the platform or that do not rest snugly on the supporter plate due to their shape and/or nature (e.g. rolling objects).

9.2 Lifting and Lowering the Platform



Before the platform is lifted, the supporter must first be fixed in place by the two lockable brakes on the front two swivel castors.

The procedure for height adjustment can be found in the following sections:

- Versions AM 500 FH and AM 1200 FH see section ⇒ 0
- Versions AM 400 ESA and AM 500 ESA see section ⇒ 9.4.2

9.3 Moving the Supporter via Swivel Castors

- Before moving the Supporter to another location, the table top and any load must always be completely lowered and any electrical cables must be disconnected.
- In addition, the load lying or standing on the table must be secured against slipping, rolling away, tipping over and falling down before moving it.
- Then release the two brakes on the front castors, push the supporter to the desired place. Before starting work secure the supporter with both brakes.

9.4 Height Adjustment

 **When adjusting the height downwards, make sure that there are no objects on the shelf under the table that are higher than the lowest position of the table top.**

 **Pay attention to the existing danger of crushing hands and fingers, especially when moving the platform downwards. Never reach under the table top during height adjustment!**

9.4.1 AM 500 FH / AM 1200 FH

The hydraulic height adjustment of the platform is based on 2 parallel column guides. The AM 500 FH has 1 hydraulic power unit in the left column, while the AM 1200 FH has two power units (1 x left and 1 x right).

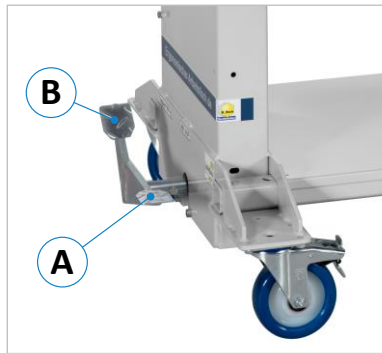

Figure 6: Foot pedal for height

- By actuating the foot pedal (A) downwards, the internal hydraulics react to the tie bars in the columns and move the table top gradually upwards. To reach the complete lifting height, approx. 40 actuations are required.
- When the foot pedal (A) is released, the movement stops and the working platform remains in this position. In order to adjust the supporter infinitely and exactly to the desired position, the foot pedal (A) can be released at any point.
- By actuating the foot pedal (B), the platform is lowered downwards for the duration of the operation.

The hydraulic force is transmitted to the hydraulic cylinder(s) via the foot pump. Foot pump and hydraulic cylinder are a fixed unit.

9.4.2 AM 400 ESA / AM 500 ESA

The electric height adjustment of the work and assembly table is based on 2 parallel column guides, each with an integrated spindle motor.

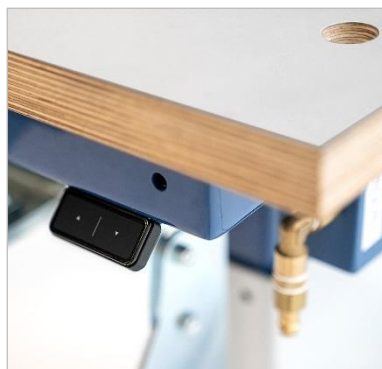



Figure 7: Control panel with buttons

- The height of the platform is adjusted via a centrally located control panel (see(⇒ Figure 7) on the table support frame.
- Use the button ▲ to move the platform upwards and the button ▼ to move downwards.
- The electric drives are controlled according to the dead man's principle, i.e. the table moves in the desired direction as long as one of the two buttons is pressed. As soon as the button is released, the table comes to a standstill and remains in this position.

The two spindle motors are concealed in the left and right lifting columns and thus protected from dirt and damage.

10 Vacuum Clamping Unit (Option)

The optionally available Vacuum Clamping Unit allows workpieces to be fixed quickly and securely. The heart of the system is the electric vacuum pump with vacuum tank and automatic switch-off, which can be placed either on the workshop floor or optionally under the table top on the lower shelf. For reliable and safe operation, the vacuum pump is supplemented with an optional foot switch, which is used to unclamp the suctioned workpieces.

	<p>The vacuum pump is an electrically operated auxiliary device.</p> <ul style="list-style-type: none"> • <i>The vacuum pump must not be operated on wet or damp ground.</i> • <i>There is a risk of short circuit with increased risk of injury!</i> • <i>Maintenance and repair work on the vacuum pump may only be carried out by authorised electricians in accordance with the electrical regulations.</i> • <i>If the connection plug is damaged or the insulation is defective, switch off the vacuum pump immediately and have it repaired.</i> • <i>In the event of a power failure or failure of the vacuum pump, there is a risk of workpieces falling down. Therefore, generally wear safety shoes with steel toe caps.</i> • <i>Caution: Danger of tripping! Lay the power supply cables and vacuum hoses so that they do not pose a trip hazard and mark them with black and yellow marking tape if necessary.</i>
---	---

Clamping the workpiece can be done in three different ways:



Figure 8: Vacuum clamping unit





Figure 9: Vacuum suction cups



Figure 10: Universal clamping plates

1. Via vacuum clamping unit with rotary axis, including 2 vacuum suction cups.
2. Via vacuum suction cups (round or oval, available in different sizes)
3. Via vacuum universal aluminium clamping plates³ (flat or swivelling version available)

	<p>Risk of injury due to high negative pressure and volume flow! Items of clothing, hair as well as skin and body parts can be sucked in and cause injuries.</p> <ul style="list-style-type: none"> • <i>Wear a hair net, protective goggles and close-fitting clothing.</i> • <i>Do not look or reach into the suction port when the pump is switched on.</i> • <i>Keep the suction port away from body parts and orifices.</i>
---	--

	<p>The penetration of liquids (e.g. coolants or lubricants) can damage the vacuum pump and reduce the adhesion of the workpiece. If necessary, connect a liquid separator between the pump and the clamping device and make sure that the workpiece is firmly seated.</p>
---	--

10.1 Switching on the Vacuum Pump





Figure 11: Vacuum main switch

Before starting up, make sure that all vacuum hoses between vacuum pump, foot switch and clamping device are correctly connected and that the vacuum clamping unit is properly fixed to the supporter. The vacuum pump can then be switched on:

- Plug the earthed plug into a power socket (230 VAC)
- Switch on the vacuum pump with the switch (S) on the earthed plug

³ Can only be mounted on supporters with a hole grid table top.

10.2 Clamping a Workpiece

	<p>Caution! Danger of crushing hands and fingers between vacuum suction cup and workpiece. Do not reach into this danger area and wear protective gloves if necessary.</p>
	<p>Danger of cutting and abrasion due to sharp workpiece edges and pointed corners. Be careful with sharp-edged and pointed workpieces and wear protective gloves if necessary.</p>

10.2.1 Clamping the Workpiece with Vacuum Suction Cups

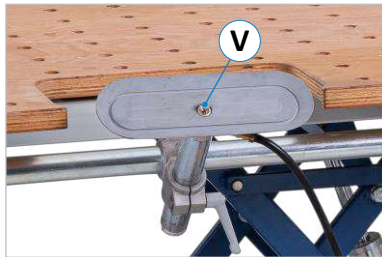



Figure 12: Suction cup valve

- Before attaching the suction cup, thoroughly clean the workpiece surface of chips, dust and dirt to ensure an optimal holding surface and to prevent dirt from being sucked into the pump.
- Each suction cup (whether round or oval) is equipped with a safety valve that triggers the vacuum by contact with the workpiece.
- The vacuum is only released after the valve (V) has been pushed inwards by the workpiece approx. 2 - 3 mm.

	<p>The penetration of chips, dust and dirt can damage the vacuum pump!</p>
---	---

10.2.2 Clamping a Workpiece with the Universal Clamping Plate

With hole grid table tops, the workpiece can alternatively be clamped via an optional universal clamping plate. There is a flat version (Art.-No. 200.405.00) as well as a 90° swivelling version (Art.-No. 200.406.00) available. The fixation on the hole grid plate is identical for both versions.



Figure 13: Quick release coupling

- For fixing on the table, the base plate is equipped with two fixed retaining bolts and one loose clamping bolt with matching grid hole spacing. The loose clamping bolt has an additional quick coupling (K), which serves to clamp the clamping plate.
- Place the universal clamping plate with the two fixed retaining bolts at the desired position in the hole grid of the table top.
- Then insert the loose clamping bolt on the opposite side through the large hole into the grid hole and clamp with quick coupling (K) by swivelling to the left (see ⇒ Figure 13).

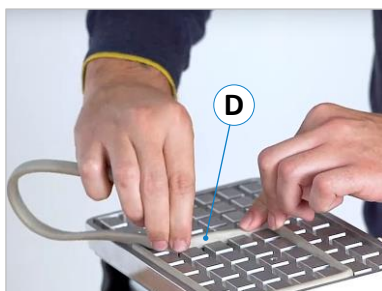

Figure 14: Rubber sealing strip

- By inserting the rubber sealing strip (D) into the finely milled grooves, the vacuum range can be adapted to the size of the workpiece (see ⇒ Figure 14).



Figure 15: Place workpiece

- Thoroughly remove chips, dust and dirt from the workpiece surface.
- Switch on vacuum pump.
- Place the workpiece and make sure that it fits tightly on the fixture.



Figure 16: Machining workpiece

- Now the workpiece can be machined.
- Before unclamping the workpiece (after machining), please follow the instructions in section ⇒ 10.3.

10.2.2.1 Swivelling Universal Clamping Plate

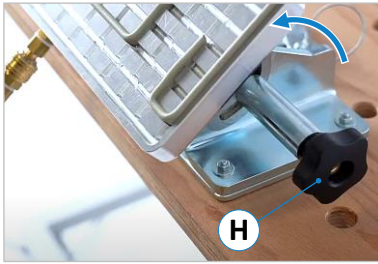

Figure 17: Swivel clamping plate

In contrast to the universal clamping plate that can be fixed flat on the table, the swivelling version (art. no. 200.406.00) can be tilted by up to 90°.

- Simply loosen the clamping wheel (H) by turning it to the left, set the desired inclination and tighten the clamping wheel again.

10.3 Unclamp Workpiece



Caution: *Danger of crushing feet and toes when unclamping the workpiece (especially with large plates)! Wear safety shoes with steel toecaps and secure LARGE panels against falling and tipping by means of the fold-out support brackets before loosening.*

Important: In order to prevent chips, dust and dirt from getting into the vacuum circuit and thus into the pump, the following measures must be carried out after workpiece machining:

- After machining or before unclamping the workpiece, thoroughly remove chips, dust and dirt from the vacuum clamping device under operating vacuum (e.g. with an industrial Hoover).
- Only then switch off the vacuum by means of the foot switch and remove the workpiece.



The penetration of chips, dust and dirt can damage the vacuum pump! Place the vacuum pump in a clean dry place and make sure, that the exhaust holes on the pump housing are kept clear at all times.



Figure 18: Foot switch for unclamping the workpiece



Figure 19: Remove workpiece

Instructions for possible troubleshooting of the vacuum clamping unit can be found in chapter ⇒ 10.2. Article numbers and other accessories for the vacuum clamping device are listed in section ⇒ 15.2.

10.3.1 Technical Specifications of the Vacuum Pump

Suction power	3,0 m ³ /h (optional 4,6 m ³ /h)	Housing	Mobile carry box
Foot switch connection	Fabric hose	Vacuum reservoir	Tank
Power connection	230 VAC / 50 Hz	Shut-off when tank is full	automatically
Connection cable	Earthed plug (5.0 m)	Connection coupling sockets	2 pieces
Weight	approx. 20 kg	Ambient temperature	0 - 40° C

11 Troubleshooting

Repair and maintenance work may only be carried out by competent, trained and instructed personnel.

	<i>Repair work on mechanical and hydraulic components may only be carried out by authorised and trained personnel.</i>
---	---

Proceed systematically when searching for the cause of a malfunction. If you are unable to find the fault or to remedy the malfunction, contact our customer service department (phone: 0049 7576 / 962 978 - 0).

Before you call us, please follow these steps:

- Make a note of the information on the nameplate of your supporter (see ⇒ Figure 2).
- Keep these operating instructions and any supplementary documents at hand.

The more precisely you describe the fault to us, the better we can then remedy the situation.

General Faults

Fault	Possible Cause	Remedy
Platform does not lower completely to the bottom	An object that is too high is lying on the shelf under the table	→ Lift the platform a little and remove the object
Platform cannot be lifted up or does not react to keystroke (ESA)	Supporter is overloaded	→ Reduce load
	Drive mechanism defective	→ Contact customer service
	Electric spindle motor defective ⁴	→ Replace spindle motor ⁴
	Control pane defective (ESA versions)	→ Contact customer service

Models with Vacuum Clamping Unit



Fault	Possible Cause	Remedy
Operating vacuum is not achieved or is too weak and the pump runs without interruption	Dust / chips / dirt between workpiece and clamping device	→ Remove contamination
	Vacuum hoses leaking	→ Replace vacuum hoses
	Vacuum hoses kinked	→ Lay hoses correctly
	Seal defective / incorrectly fitted	→ Replace / install correctly
Clamping surface damaged	Workpiece incorrectly machined	→ Contact customer service
Vacuum pump does not start	Pump motor defective	→ Contact customer service
Insufficient holding force for workpiece machining	Clamping surface too small	→ Reduce load
	Vacuum hoses are too narrow or too long	→ Increase diameter or shorten hoses
	Vacuum hoses are clogged	→ Remove blockage
	Suction cups do not close tightly to the workpiece, workpiece surface is too rough or rubber sealing is porous	→ Use suitable suction cups → Check rubber seal → Install stronger pump ⁵

⁴ Replacement spindle motors: ESA 400: Manufacturer "Ketterer"; In-line actuator; Type "40NP3120.00-0051".
ESA 500: Manufacturer "Bansbach"; linear in-line actuator; type "EASYE-50 EEL-50-00000308".

⁵ A vacuum pump with 4.6 m³/h (instead of 3.0 m³/h) is available (Art. No. 210.450.00).

12 Maintenance and Repair

Maintenance and repair work may only be carried out by competent, trained and instructed personnel. If necessary, further operating instructions and/or additional documents must be observed.

 	<p>After maintenance or repair work on the work and assembly table, always carry out a function test.</p> <ul style="list-style-type: none"> • Before starting work, disconnect all power supply lines. • Before working on the hydraulic system, depressurise it by lowering the supporter. • Wear safety shoes with steel-toed caps. • Wear suitable protective clothing.
--	--

	<p>Repair work on mechanical, electrical, pneumatic and hydraulic components may only be carried out by authorised and trained personnel.</p>
---	--

	<p>Before any maintenance and repair work is carried out, chapter ⇨ 4 "Safety" must be read carefully and observed.</p>
---	--

12.1 Maintenance Intervals

Interval	Action
Daily	Check all components for damage and have them replaced by competent personnel if necessary. If you have any questions, please contact our support (phone: 0049 7576 / 962 978 - 0).
Monthly	Lubricate the castors and bearings a little.
Annual	Make and document annual inspection of the supporter according to regulations.

13 Decommissioning

- Before decommissioning, all power supplies must be disconnected properly.
- Before taking out of service, the platform of the supporter must be lowered completely.
- For recommissioning, observe chapter ⇨ 8 "Installation and commissioning".

14 Disassembly and Scrapping

When dismantling and scrapping the Supporter, the current EU regulations or the respective regulations and laws of the country of operation, which are prescribed for proper dismantling and disposal, must be observed. The aim is to dismantle the Supporter and its various materials and components properly, to recycle all possible parts and to dispose of non-recyclable components in the most environmentally friendly way.

	<p>Please pay particular attention to</p> <ul style="list-style-type: none"> • <i>the dismantling of the Supporter in the working area</i> • <i>proper dismantling of the Supporter and accessories</i> • <i>a safe and proper removal of the Supporter</i> • <i>proper separation of all components and materials.</i>
---	--

When dismantling and disposing the Supporter, the laws and regulations in force at the place of use concerning health and environmental protection must be observed.

	<p>Remove all residues of oil, grease and other lubricants and have them disposed of properly by a qualified disposal company.</p>
---	---

When separating, disposing of or recycling the Supporter materials, comply with the environmental protection laws in force at the place of use regarding the disposal of industrial solid waste toxic and hazardous waste.

	<ul style="list-style-type: none"> • <i>Hoses and plastic parts as well as other components that are not made of metal must be dismantled and recycled or disposed of separately.</i> • <i>Electrical components such as cables, switches, connectors, transformers, etc. must be removed and (if possible) recycled or otherwise disposed of in a qualified manner.</i> • <i>Pneumatic and hydraulic parts such as valves, solenoid valves, pressure regulators, etc. must be removed and (if possible) recycled or otherwise disposed of in a qualified manner.</i> • <i>Dismantle the base frame and all metal parts of the Supporter and sort them according to material type. Metals can be melted down and recycled.</i>
--	--

In the event of improper disposal of lubricants, the following residual risks to the environment and health exist:

	<p>Pollution of the environment by seepage into groundwater or sewage system.</p>
---	--

	<p>Poisoning of the personnel contracted for the disposal.</p>
---	---

Note: The disposal of lubricants considered toxic and hazardous must be carried out in accordance with the regulations and laws in force at the respective place of use. Only qualified disposal companies that have the appropriate permits for the disposal of used oil and lubricants are to be commissioned with the disposal.

15 Options and Accessories

In the following tables you will find available options and accessories that you can use to upgrade your work and assembly bench. Please also visit our online shop <https://www.hokubema.com>.

	<p>Only use the original accessories and spare parts specified by the manufacturer. The use of other accessories or spare parts may cause injury to persons and damage to the work and assembly bench. The manufacturer accepts no liability for any damage resulting from the use of non-prescribed accessories and spare parts or additional components from third parties!</p>
---	--

15.1 Table Tops, Shelves, Supports etc.

Article	Description	Art.-No.
METAL SHEET TABLE TOP SMOOTH	Suitable for supporter AM 500, screwed onto platform. <i>Platform size = 1500 x 790 x 3 mm Weight approx. 18 kg</i>	210.317.00
TABLE TOP BEECH-MULTIPLY	Suitable for Supporter AM 500, screwed onto platform, plate is coated with linseed oil. <i>Platform size = 1600 x 790 x 30 mm Weight approx. 30 kg</i>	210.300.00
HOLE GRID TABLE TOP BEECH-MULTIPLY	Suitable for supporter AM 500, screwed onto platform, plate is coated with linseed oil. <i>Platform size = 1600 x 790 x 30 mm Holes $\varnothing = 22$ mm Grid hole pitch T = 100 mm Weight approx. 29 kg</i>	210.310.00
TABLE TOP BIRCH-MULTIPLY, BOTH SIDES HPL-COATED	Suitable for all supporter versions, screwed onto platform. <i>Platform size = 1600 x 790 x 30 mm Colour RAL 9016 (traffic-white) Weight approx. 30 kg</i>	210.306.00
HOLE GRID TABLE TOP BIRCH-MULTIPLY, BOTH SIDES HPL-COATED	Suitable for all supporter versions, screwed onto platform. <i>Platform size = 1600 x 790 x 30 mm Holes $\varnothing = 22$ mm Grid hole pitch T = 100 mm Colour RAL 9016 (traffic-white) Weight approx. 29 kg</i>	210.311.00
FOLDABLE SHELF, ON THE RIGHT SIDE	Suitable for all supporter versions, attached to the base frame on the right-hand side, provides space for tools, accessories, Hoover, vacuum pump, etc. <i>Platform size = 445 x 390 mm Weight approx. 12 kg</i>	210.321.00
VERTICAL SUPPORT, LEFT AND RIGHT SIDE	Suitable for all supporter versions, height adjustable in 50 mm hole grid. <i>Weight approx. 10 kg</i>	210.330.00

For further information and figures as well as pre-configured supporters refer to our [catalogue](#).

Continuation "15.1 Table Tops, Shelves, Supports, etc."

Article	Description	Art.-No.
STEEL HOLE GRID TABLE TOPS	Suitable for all supportors, made of high-quality steel, mechanically machined with high precision, corrosion-resistant and long-lasting wear protection thanks to plasma-nitrided surface. Ideal for use in assembly work and as a welder's plate for filigree welding work. Plate construction reinforced by cassette-shaped welded-in web plates.	
SYSTEM 16 WITH 50 MM SIDE WALLS	<i>Platform size = 1500 x 1000 x 50 mm Side wall height = 50 mm Bore distance side wall = 50 mm Weight approx. 170 kg</i>	200.440.16
SYSTEM 28 WITH 200 MM SIDE WALLS	For Supporter AM 1200 stationary, including scaling on the surface. <i>Platform size = 1500 x 1000 x 200 mm Side wall height = 200 mm Bore distance side wall = 50 mm Weight approx. 510 kg</i>	200.442.28
METAL HOLE GRID TABLE TOP	Suitable for all supportors, screwed onto platform, for use in assembly work and as a welding plate for filigree welding work. Phosphated surface. <i>Size = 1600 x 1200 x 65 mm Thickness = 4 mm Weight approx. 96 kg Side wall H = 65 mm Holes \varnothing = 28 mm Diagonal grid T = 100 mm</i>	200.616.00
STAINLESS STEEL TABLE TOP, SMOOTH	Suitable for all supportors, screwed onto beech-multiplex table top, with all-round bevelling 20 mm on all 4 sides. <i>Size 1600 x 790 x 32 mm Thickness = 2 mm Weight approx. 48 kg</i>	210.318.00
SIDE STOP RAILS 90°	Suitable for all supportors, 30 mm height-adjustable and can be lowered below the level of the table top, with several clamping levers. <i>2 piece Set: 1 stop rail on one long side (L = 1550 mm) 1 stop rail on one narrow side (L = 770 mm) Weight approx. 20 kg</i> Can only be used in conjunction with the following table tops: Art.-No. 210.317.00 210.300.00 210.310.00 210.306.00 210.311.00	200.312.00
STATIONARY VERSION	Suitable for all supportors, 4 foot plates with threaded bolts, adjustable +/- 15 mm for floor levelling. <i>Weight approx. 6 kg</i>	200.020.00
DIRECTION LOCK	1 piece steering stop for swivel castor. The direction stop turns the swivel castor into a fixed castor. The steering direction is stabilised. <i>Weight approx. 1 kg</i>	200.001.00

For further information and figures as well as pre-configured supportors refer to our [catalogue](#).

15.2 Vacuum Clamping Unit

Article	Description	Art.-No.
VACUUM CLAMPING UNIT WITH ROTARY AXIS AND VACUUM SUCTION CUPS	Suitable for all supportors with vacuum. The vacuum clamping unit with rotary axis can be swivelled continuously by 90° (from vertical to horizontal) for an optimum working position when working on the workpiece. Including 2 movable, oval 300 x 100 mm vacuum suction cups (exchangeable thanks to quick clamping system) with touch valve and holder. The clamping unit can be completely retracted under the table top.	210.340.00
ELECTRIC VACUUM PUMP IN MOBILE TRANSPORT BOX	Suitable for all supportors with vacuum, can be placed on the lower shelf, dry-running and low-maintenance, electric vacuum pump with vacuum tank and automatic switch-off in mobile carrying box, with 2 connection sockets. <i>Suction power 3,0 m³/h Foot switch with 1.5 m fabric hose 5 m cable with earthed plug (230 VAC/50Hz) Weight approx. 20 kg</i>	210.440.00
VACUUM PUMP WITH MORE SUCTION POWER	Suitable for all supportors, incl. 2 connection coupling sockets. <i>Suction capacity 4,6 m³/h Foot switch with 1.5 m fabric hose 5 m connection cable with earthed plug (230 VAC/50Hz) Weight approx. 20 kg</i>	210.450.00
FOOT SWITCH	For clamping and unclamping the workpiece. Optional for electric vacuum pump in carrying box (Art.-No. 210.440.00 and 210.450.00). <i>Function 3/2 way valve Weight approx. 2 kg.</i>	210.455.00
VACUUM SUCTION CUP OVAL	Suitable for the rotary axis. With the vacuum system, the vacuum grippers are interchangeable by means of the quick-change system. <i>Infinitely height adjustable (200 mm) Weight approx. 3 kg</i>	210.341.00 (300 x 100 mm) 210.359.00 (300 x 100 mm)
VACUUM SUCTION CUP ROUND	Suitable for the rotary axis. With the vacuum system, the vacuum grippers are interchangeable by means of the quick-change system. <i>Infinitely height adjustable (200 mm) Weight approx. 3 kg</i>	210.342.00 (Ø 100 mm) 210.343.00 (Ø 125 mm) 210.347.00 (Ø 200 mm)
UNIVERSAL VACUUM CLAMPING PLATE, FLAT	Suitable for all models with hole grid plate, flat version with quick coupling for mounting on the perforated grid plate. Including 1 m rubber sealing strip. Material aluminium, surface: finely milled with grid grooves for inserting a sealing strip. <i>Format = 290 x 160 x 40 mm Weight approx. 2 kg</i>	200.405.00
UNIVERSAL VACUUM CLAMPING PLATE, SWIVELING	Suitable for all models with hole grid plate, 90° swivelling version with quick coupling for mounting on the perforated grid plate. Including 1 m rubber sealing strip. Material aluminium, surface: finely milled with grid grooves for inserting a sealing strip. <i>Format = 290 x 160 x 40 mm Weight approx. 3 kg</i>	200.406.00

For further information and figures as well as pre-configured supportors refer to our [catalogue](#).

15.3 Drawers, Tool Cabinets and other Accessories

Article	Description	Art.-No.
OVERHEAD LIGHT FIXTURE AND DEVICE HOLDER	Suitable for all supporters, mounted on the upper adjustable platform frame, made of aluminium profiles with LED 400K, surface-mounted luminaire, light switch and 2 appliance sockets with cover (230 V). <i>LED 4000K Surface-mounted luminaire 35 W Weight approx. 40 kg</i>	210.600.00
MOVABLE EQUIPMENT TROLLEY	Suitable for all supporters, mounted on the unit support rail for the attachment of functional parts. <i>Laterally movable by 800 mm Weight approx. 10 kg</i>	210.603.00
ENERGY BAR WITH CENTRAL AIR AND POWER CONNECTION	Suitable for all supporters, mounted on the right narrow side. Includes 3 m long cable (230 VAC). <i>3 x Earthed sockets with cover 4 x Compressed air quick couplings Weight approx. 10 kg</i>	200.407.00
COMPRESSED AIR MAINTENANCE UNIT WITH 2 COUPLINGS (FUNCTIONAL PART)	Suitable for all supporters, mounted on equipment trolley. <i>Maintenance unit R 3/8" 2 x Safety couplings 3/8" NW 7,2 Weight approx. 8 kg</i>	210.605.00
EARTHED SOCKETS WITH COVER, 2 PIECES (FUNCTIONAL PART)	Suitable for all supporters, mounted on equipment trolley. <i>Earthed sockets 230 VAC I_{max} = 10/16 A Weight approx. 10 kg</i>	210.604.00
BALANCER (FUNCTIONAL PART)	Suitable for all supporters, mounted on equipment trolley. <i>Adjustable range 0.6 bis 2.0 kg Weight approx. 2 kg</i>	210.606.00
EQUIPMENT SUPPORT RAIL	Suitable for all supporters, mounted on overhead unit. <i>C-Rail = 30 x 32 x 2 mm, 1800 mm long Weight approx. 10 kg</i>	210.601.00
MULTIPLEX TOOL BASE CABINET WITH 2 DRAWER BLOCKS	Suitable for all supporters, incl. 6 drawers. <i>Outer dimensions (body) W x H x D = 1100 x 370 x 500 mm 2 x Drawers 620 x 40 x 420 mm 1 x Drawer 620 x 120 x 420 mm 2 x Drawers 360 x 40 x 420 mm 1 x Drawer 360 x 120 x 420 mm Weight approx. 40 kg</i>	210.620.00
METAL DRAWER BASE CABINET WITH 1 DRAWER BLOCK	Suitable for all supporters, drawers with perforated bottom and slotted walls (for individual drawer subdivision), central locking with 2 keys, with labelling strip and transparent cover. <i>Outer dimensions (body) W x H x D = 1060 x 330 x 675 mm 1 x Drawer 1058 x 328 x 675 mm Usable size = 900 x 255 x 600 mm Load capacity max. 100 kg 100 % Full-extension and single pull-out stop Colour light grey RAL 7035 or blue RAL 5023 Weight approx. 40 kg</i>	210.641.00
METAL DRAWER BASE CABINET WITH 2 DRAWER BLOCKS	Suitable for all supporters, drawers with perforated bottom and slotted walls (for individual drawer subdivision), central locking with 2 keys, with labelling strip and transparent cover. <i>Outer dimensions (body) W x H x D = 1090 x 330 x 675 mm Block 1 front height = 270 mm 1 x Drawer usable size 410 x 255 x 600 mm Block 1 front height = 90 mm 3 x Drawers usable size 410 x 75 x 600 mm Load capacity max. 100 kg Colour light grey RAL 7035 or blue RAL 5023 RAL 5023 Weight approx. 48 kg</i>	210.642.00

For further information and figures as well as pre-configured supporters refer to our [catalogue](#).

15.4 AM 500 FLEXX | FH and AM 1200 FLEXX | FH

The two foot-hydraulically height-adjustable versions "FLEXX" are pre-configured models. As standard, these models are equipped with five laterally adjustable C-profile support rails (1) and hardwood supports. The hardwood supports in the C-profile rail are adjustable in depth. In addition, the FLEXX models offer a lot of space, as they are standard-equipped with a large-surface shelf.

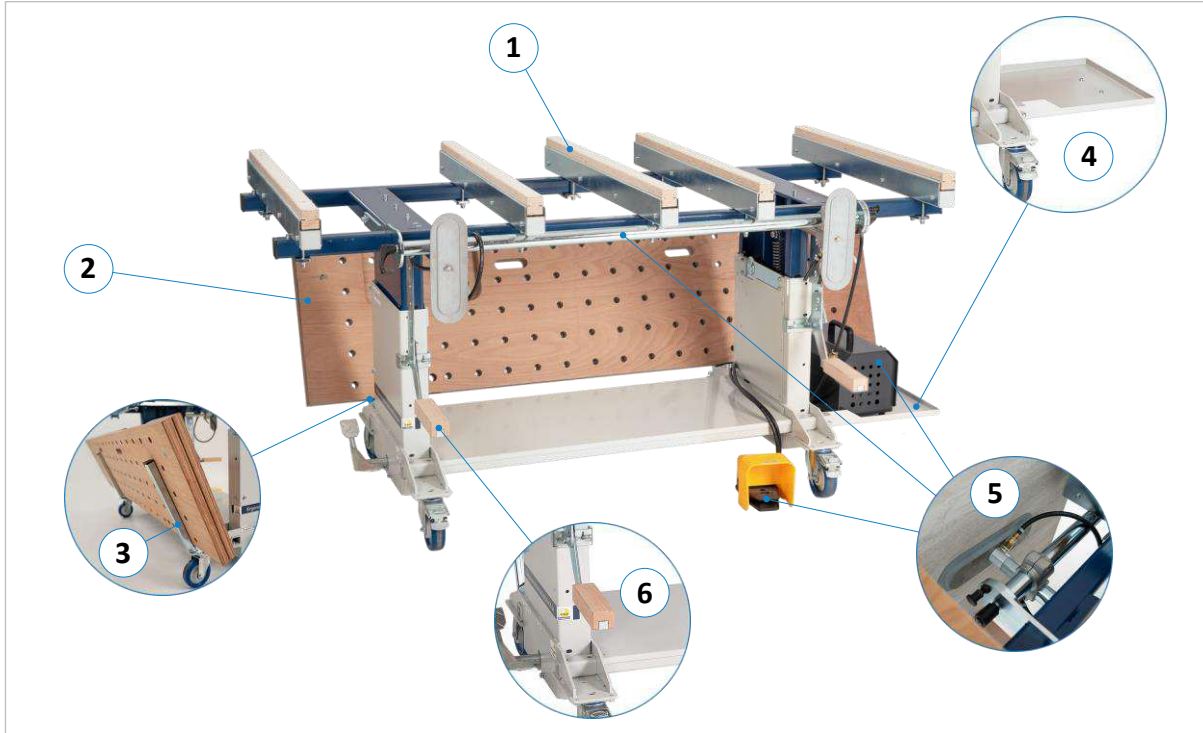

Figure 20: AM 500 -1200 FLEXX | FH

Pos.	Description	Pos.	Description
1	C-Profile Rails + Hardwood Supports (Standard equipment for FLEXX models)	4	Foldable Shelf, on right side (option, see ⇒ 15)
2	Hole Grid Table Top (option, see ⇒ 15.4.1)	5	Vacuum Clamping Unit with Vacuum Pump and Foot Switch (option, see ⇒ 15.2)
3	Supports (are included in the scope of delivery for optional Table Tops, see ⇒ 15.4.1)	6	Vertical Support left/right (option, see ⇒ 15)

Article Numbers:

Article	Description	Art.-No.
AM 500-FLEXX FH	Load capacity up to 500 kg, with 1 lifting unit in the left column, including storage shelf under the table top. <i>Platform size = 2000 x 1000 mm Effective stroke = 300 mm Construction height = 770 mm Weight approx. 150 kg</i>	210.130.00
AM 1200-FLEXX FH	Load capacity up to 1200 kg, with 2 lifting units (1 x left and 1 x right), including storage shelf under the table top. <i>Platform size = 2000 x 1000 mm Effective stroke = 300 mm Construction height = 770 mm Weight approx. 180 kg</i>	210.140.00

Optional table tops see ⇒ 15.4.1 on the next page.

15.4.1 Table Tops for AM 500 - 1200 FLEXX | FH

Note: The two supports (3) are included in the scope of delivery for all table tops (⇒ Figure 20). When not in use, the table top can be stored behind the table for easy access.

Article	Description	Art.-No.
HOLE RIDGE TABLE TOP BEECH MULTIPLEX, 2-PIECES - WITHOUT CUT-OUTS –	Suitable for AM 500-Flexx + AM 1200-Flexx, with 2 plug-in bolts for attachment to the 2 outer support rails, incl. 2 dovetail connectors (double T-connectors), plate is coated with linseed oil. <i>Platform size = 2 x 2000 x 500 x 30 mm Holes \varnothing = 22 mm Grid hole pitch T = 100 mm Weight approx. 42 kg</i>	210.460.00
HOLE RIDGE TABLE TOP BEECH MULTIPLEX, 2-PIECES - WITH TWO CUT-OUTS –	Suitable for AM 500-Flexx + AM 1200-Flexx, 2 cut-outs for vacuum suction cups oval (300 x 100 mm) with 2 plug-in bolts for attachment to the 2 outer support rails, incl. 2 dovetail connectors (double T-connectors), plate is coated with linseed oil. <i>Platform size = 2 x 2000 x 500 x 30 mm Holes \varnothing = 22 mm Grid hole pitch T = 100 mm Weight approx. 42 kg</i>	210.465.00
HOLE RIDGE TABLE TOP BIRCH MULTIPLEX, HPL-COATED, 2-PIECES - WITHOUT CUT-OUTS –	Suitable for AM 500-Flexx + AM 1200-Flexx, with 4 plug-in bolts for attachment to the 2 outer support rails, incl. 2 dovetail connectors, plate is coated with linseed oil. <i>Platform size = 2 x 2000 x 500 x 30 mm Holes \varnothing = 22 mm Grid hole pitch T = 100 mm Colour RAL 9016 (traffic-white) Weight approx. 42 kg</i>	210.312.00
HOLE RIDGE TABLE TOP BIRCH MULTIPLEX, HPL-COATED, 2-PIECES - WITH TWO CUT-OUTS –	Suitable for AM 500-Flexx + AM 1200-Flexx, 2 cut-outs for vacuum suction cups oval (300 x 100 mm), with 4 plug-in bolts for attachment to the 2 outer support rails, incl. 2 dovetail connectors, plate is coated with linseed oil. <i>Platform size = 2 x 2000 x 500 x 30 mm Holes \varnothing = 22 mm Grid hole pitch T = 100 mm Colour RAL 9016 (traffic-white) Weight approx. 42 kg</i>	210.313.00
EXTENSION SYSTEM ON ONE SIDE, WITH HARDWOOD TOP	Platform extension by one-sided pull-out up to 820 mm, suitable for Supporter AM 500-Flexx + AM 1200-Flexx, screwed onto platform. <i>Support surface per side = 1000 x 60 mm Weight approx. 20 kg</i>	210.314.00
EXTENSION SYSTEM LEFT AND RIGHT, WITH HARDWOOD TOP	Platform extension by two-sided pull-out up to 820 mm, suitable for Supporter AM 500-Flexx + AM 1200-Flexx, screwed onto platform. <i>Support surface per side = 1000 x 60 mm Weight approx. 40 kg</i>	210.325.00

For further information and figures as well as pre-configured supporters refer to our [catalogue](#).

EU - Declaration of Conformity

in accordance with the EU Machinery Directive 2006/42/EC Annex II A

The manufacturer,

Fa. Reinhold Beck
Maschinenbau GmbH
Im Grund 23
DE-72505 Krauchenwies (Germany)
Phone: 0049 - 7576 962 978 0
Fax: 0049 - 7576 962 978 90

hereby declares that the manufactured machine

Model: **AM 500 FH / AM 1200 FH / AM 400 ESA / AM 500 ESA**
Type designation: Lifting Table
Serial number(s):
Year of manufacture:

in the version provided complies with the EU Machinery Directive 2006/42/EC and the following further directives:

The following harmonised standards and instructions have been applied in manufacturing the machine:

- **EN ISO 12100:2010** Safety of machinery - General principles for design - Risk assessment and risk reduction
- **EN 1570-1:2011** Safety requirements for lifting tables

Name: Beck
First name: Reinhold
Position: Managing Director

Krauchenwies, 17.11.2021

Place and date



Signature